

RAK
CERAMICS

CONCEPT

MAXIMUS MEGA SLAB 2023

RAK
CERAMICS

MAXIMUS
MEGA SLAB

Concept and
Solutions



MAXIMUS
MEGA SLAB

RAK
CERAMICS

Concept and Solutions

CONTENTS

MARBLE

ARABESCATO 46
ARMANI COPPER 47
ARMANI GOLD 48
BLACK BEAUTY 49
BLACK EMPERADOR 50
BLACK GOLD 51
BLUEDEL BELGIO BLUE 52
BLUEDEL BELGIO CLAY 53
GREAT EMPERADOR 54
EMPERADOR STONE 55
FLURRY GREY 56
GRANA PORTORO 57
ELLE MARBLE BLACK 58
MARQUINA BLACK 59
ONYX WHITE 60
POLISHED BROWN 61
REGAL BEIGE 62
ROLEX GREY 63
SILK MARBLE GREY 64
SILVER RIVER 66
BOTTICINO LARGE 67
BRECCIA AURORA 68
STATUARIO SILK 69
CARARA GOLD 70
CARARA GREY 71
CLASSIC BEIGE 72
FIORITO BEIGE 73
GARFAGNANA BM 74
ICE BERG 75
MARFIL BEIGE 76
ICE GREY 78
MILKY WAY 79
NEW MARFIL BEIGE 80
NEW TRAVERTINO IVORY 81
BRUSSA BEIGE 82
REAGAN CREMA 83
AMANI 84
NOIR ST LAURENT 87
BRECCIA BROWN 85
DARK EMPERADOR 86

ANTIQUÉ BEIGE 88
DYNA 89
GARFAGNANA 90
LAWRANCE GREY 91
MONTANA BEIGE 92
TRAVERTINO LIGHT BEIGE 93
AUSTEN 98
BELITA BEIGE 100
BRONTE 102
COPPERFIELD BEIGE 104
CHARLES BIANCO 106
CRYSTAL GREY 107
FORSTER 108
ORWELL GREY 111
OSCAR 112
SYLVIA BRECCIA VERDE 114
YEATS BRECCIA BEIGE 116
RUDYARD BEIGE 118
ACADIA BEIGE 119
ANGELFISH 120
FLAMINGO 124
GRAND CANYON 126
GULARIS 130
KEEL WHITE 132
MAGNOLIA BEIGE 133
PULPIS LIGHT BROWN 134
MACAW BLUE 135
LORIKEET BROWN 136
ORIOLE 137
PASSERINA 140
PUFFIN GREY 141
TURACOS LIGHT GREY 143
OYSTER MARFIL 156
ALPS BEIGE 157
ARIA BIANCO 158
ARMANI GRIGIO 159
BOTTOCHINO SUPREME 160
DYNA REGAL BEIGE 161
BRECCIA NATURAL 162
COSMOS CREMA 164

GRACIOUS BEIGE 165
HARBOUR GREY 166
HONEY STRIATO ONYX 168
LEXUS BROWN 169
MARFIL MAJESTIC 170
NEW SCREPLATO LBR 171
NEW SCREPLATO NIGHT 172
ONYX URBAN 174
PLATINUM GREY 175
STATUARIO LARGE 176
THALES GREY 177
THALES BEIGE 178
STATUARIO SVARNAM 180
TOURMALINE GREY 181
VERASACE ORO 182
WONDER GREY 184
KANSAS IVORY 185
BRUGES WHITE 186
PROCIDA BEIGE 187
CARARA WHITE 188
PERLATO SICILIY 189
PALERMO WHITE 190
CARDINAL CLASSIC 191
WILLIAM GREY LEGEND 192
KENTUCKY BEIGE 193
OPAL BROWN 194
FLORENCE BEIGE 196
MISSOURI BLUE 197
MICHIGAN BEIGE 198
HEMROCK GREY 199
WONDER BROWN 200
LASA BIANCO 202
GEORGIA GREY 203
FLORIDA BROWN 204
MONTANA BEIGE 205
NEW JERSEY GREY 206
NEVADA GREY 207
CAROLINA GREY 208
DELAWARE GREY 209
DOVER BROWN 210

FRANKLIN BEIGE 211
SCANDINAVIAN GREY 212
IRISH GREY 213
MINNESOTA BARLEY 214
MINNESOTA BLACK 215
MINNESOTA GREY 216
MINNESOTA TAUPE 217
MINNESOTA ALMOND 218
RHAPSODY LT BROWN 220
RHAPSODY BROWN 221
RHAPSODY AVORIO 222

CONCRETE

SURFACE XL 238
BASIC CONCRETE XL GREY 239
MEGALITH 240
EURO ELEGANTE 241
COLERIDGE 242
CONRAD CEMENT 243
SIGNUM 244

METAL

ICON METAL BROWN 252
ICON METAL LIGHT GREY 252
IGNAZIO BROWN 253

STONE

HOPPER 258

The design possibilities are endless.

Imagine a tiled space with virtually no grout lines.
Imagine limitless possibilities for your surfaces and unparalleled flexibility for any kind of applications.
Maximus is available in 9 mm thicknesses and a wide range of finishes and sizes.
Heat resistance, recyclable, light weight, durable and easy to clean.
Maximus is the best answer to the most challenging architectural and interior design needs.

120x240 cm
47.24"x94.48"
>|< 9 mm

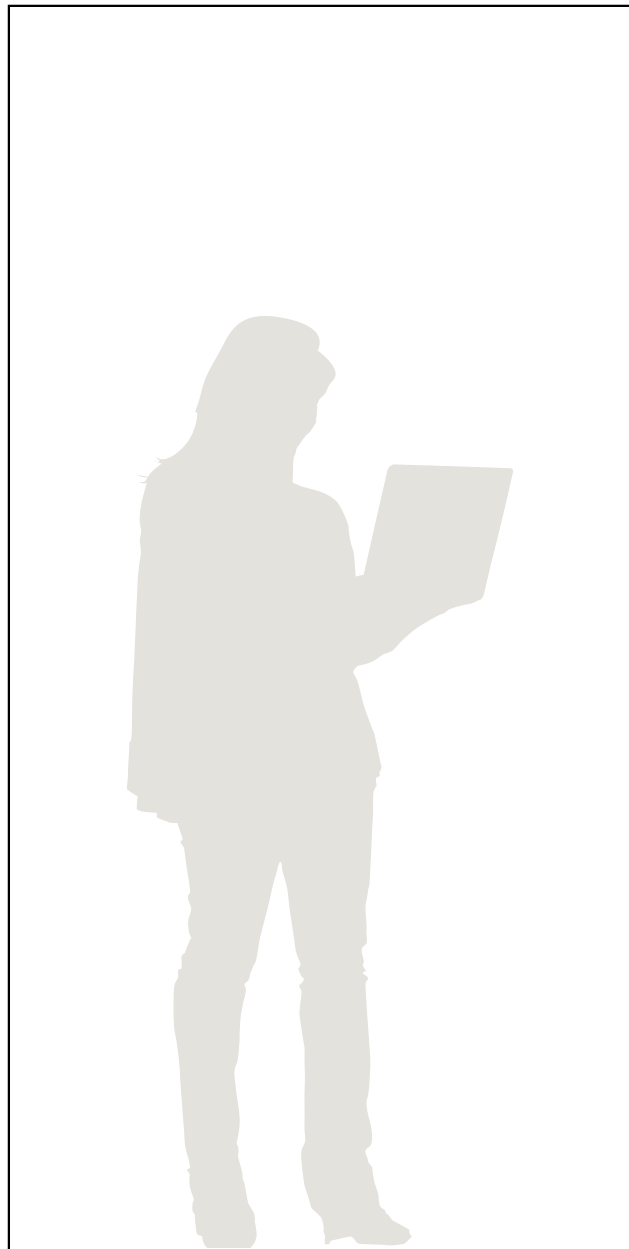

120x180 cm
47.24"x70.86"
>|< 9 mm

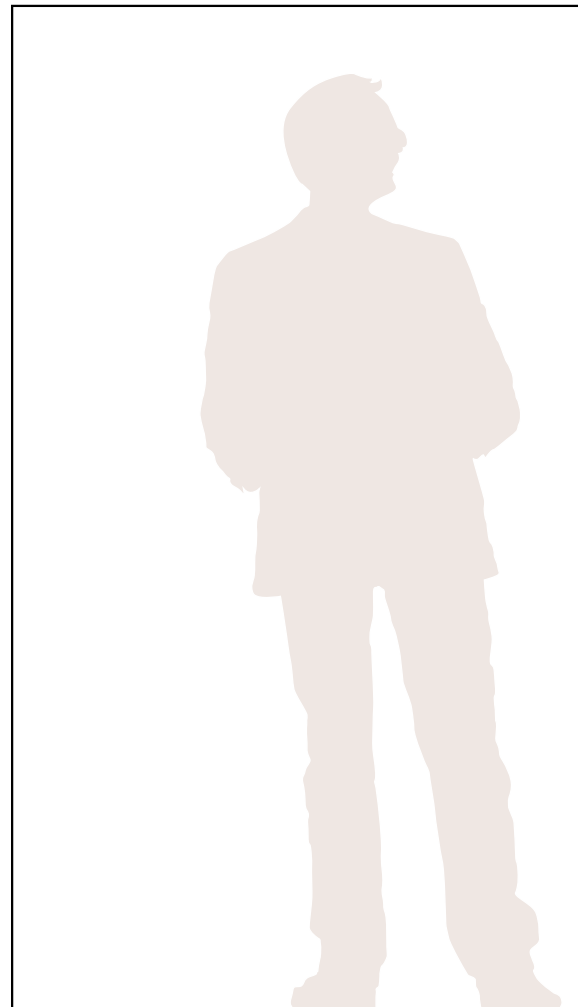

80x160 cm
31.49"x62.99"
>|< 9 mm



120x120 cm
47.24"x47.24"
>|< 9 mm

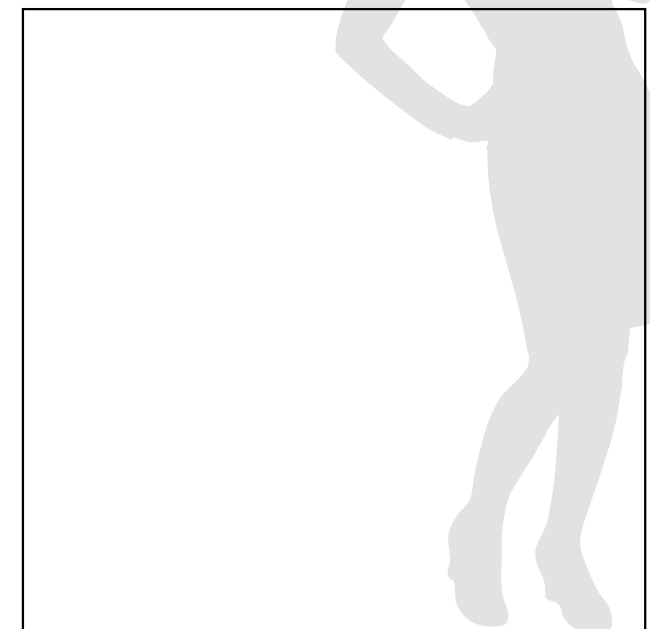

Versatile and simply beautiful, the Maximus slab revolutionizes the design and architecture world by opening up new perspectives in tiles application that were previously unimaginable.

All the continuous surfaces are designed for any type of application: floor and walls, cladding, furnishing, countertops and provide creative flexibility and high technical and aesthetic performances.

WALLS AND FACADE

FURNITURE

FLOOR



Wall

The best solution to create astonishing vertical surfaces like kitchen walls, bathroom and all the other walls. Maximus gives to all your rooms a great personality and allows you to freely express your style.



Floor

Maximus has created a world where big is beautiful - with visually expanded spaces and fewer design interruptions. The application on the floor is the best way to appreciate its endless possibilities, exhibiting incredible aesthetic appeal and high resistance to stress.



Facade

The technical performances of the gigantic sized Maximus slabs are the perfect solution for the external cladding of buildings. High resistance, light weight, easy to install and maintain, with a high aesthetic and energy value that enhance the building industry.

ARABESCATO 46
ARMANI COPPER 47
ARMANI GOLD 48
BLACK BEAUTY 49
BLACK EMPERADOR 50
BLACK GOLD 51
BLUEDEL BELGIO BLUE 52
BLUEDEL BELGIO CLAY 53
GREAT EMPERADOR 54
EMPERADOR STONE 55
FLURRY GREY 56
GRANA PORTORO 57
ELLE MARBLE BLACK 58
MARQUINA BLACK 59
ONYX WHITE 60
POLISHED BROWN 61
REGAL BEIGE 62
ROLEX GREY 63
SILK MARBLE GREY 64
SILVER RIVER 66
BOTTICINO LARGE 67
BRECCIA AURORA 68
STATUARIO SILK 69
CARARA GOLD 70
CARARA GREY 71
CLASSIC BEIGE 72
FIORITO BEIGE 73
GARFAGNANA BM 74
ICE BERG 75
MARFIL BEIGE 76
ICE GREY 78
MILKY WAY 79
NEW MARFIL BEIGE 80
NEW TRAVERTINO IVORY 81
BRUSSA BEIGE 82
REAGAN CREMA 83
AMANI 84
BRECCIA BROWN 85
DARK EMPERADOR 86
NOIR ST LAURENT 87

ANTIQUE BEIGE 88
DYNA 89
GARFAGNANA 90
LAWRANCE GREY 91
MONTANA BEIGE 92
TRAVERTINO LIGHT BEIGE 93
AUSTEN 98
BELITA BEIGE 100
BRONTE 102
COPPERFIELD BEIGE 104
CHARLES BIANCO 106
CRYSTAL GREY 107
FORSTER 108
ORWELL GREY 111
OSCAR 112
SYLVIA BRECCIA VERDE 114
YEATS BRECCIA BEIGE 116
RUDYARD BEIGE 118
ACADIA BEIGE 119
ANGELFISH 120
FLAMINGO 124
GRAND CANYON 126
GULARIS 130
KEEL WHITE 132
MAGNOLIA BEIGE 133
PULPIS LIGHT BROWN 134
MACAW BLUE 135
LORIKEET BROWN 136
ORIOLE 137
PASSERINA 140
PUFFIN GREY 141
TURACOS LIGHT GREY 143

MARBLE





MARBLE

A wide and varied range of collections inspired by the elegance of marble to offer hundreds of solutions for residential areas, hospitality industry and business places. Revised classy marble and granite patterns displaying elegant veins which remodel walls, floors, countertops and furniture, creating sophisticated ambiances. Maximus marble collections are the epitome of luxury and sophistication. Also available in the trendy Open Book effect in a huge range of sizes, thicknesses and design solutions.



Wall: Carara Grey
Floor: Carara Grey



Wall: Milky Way
Floor: Milky Way



Wall: Blu Del Belgio Clay
Floor: Blu Del Belgio Clay
Kitchen Top: Blu Del Belgio Blue



Floor: Breccia Brown

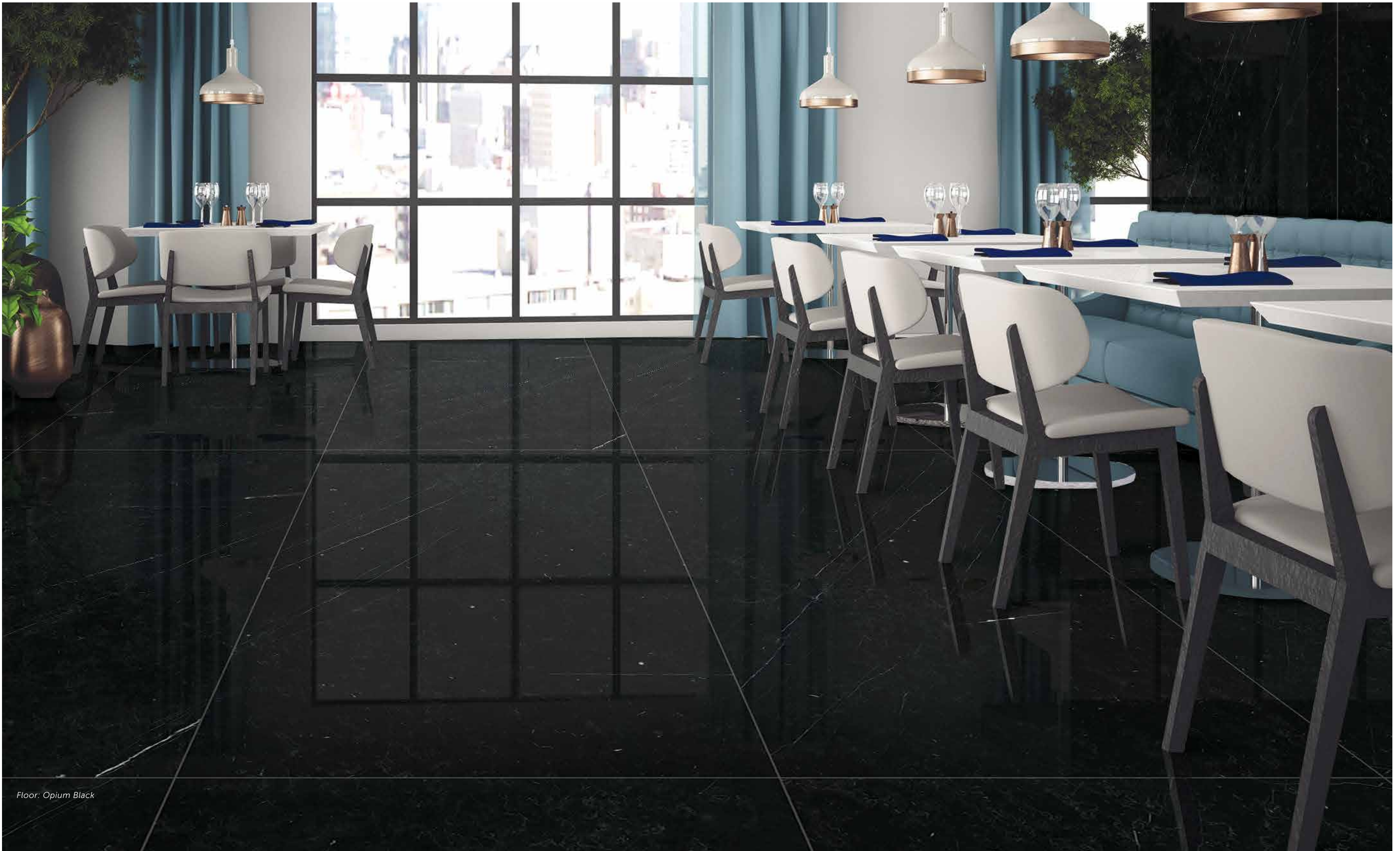

Floor: Opium Black



Floor: Grana Portoro



Floor: Black Beauty
Wall: Black Beauty

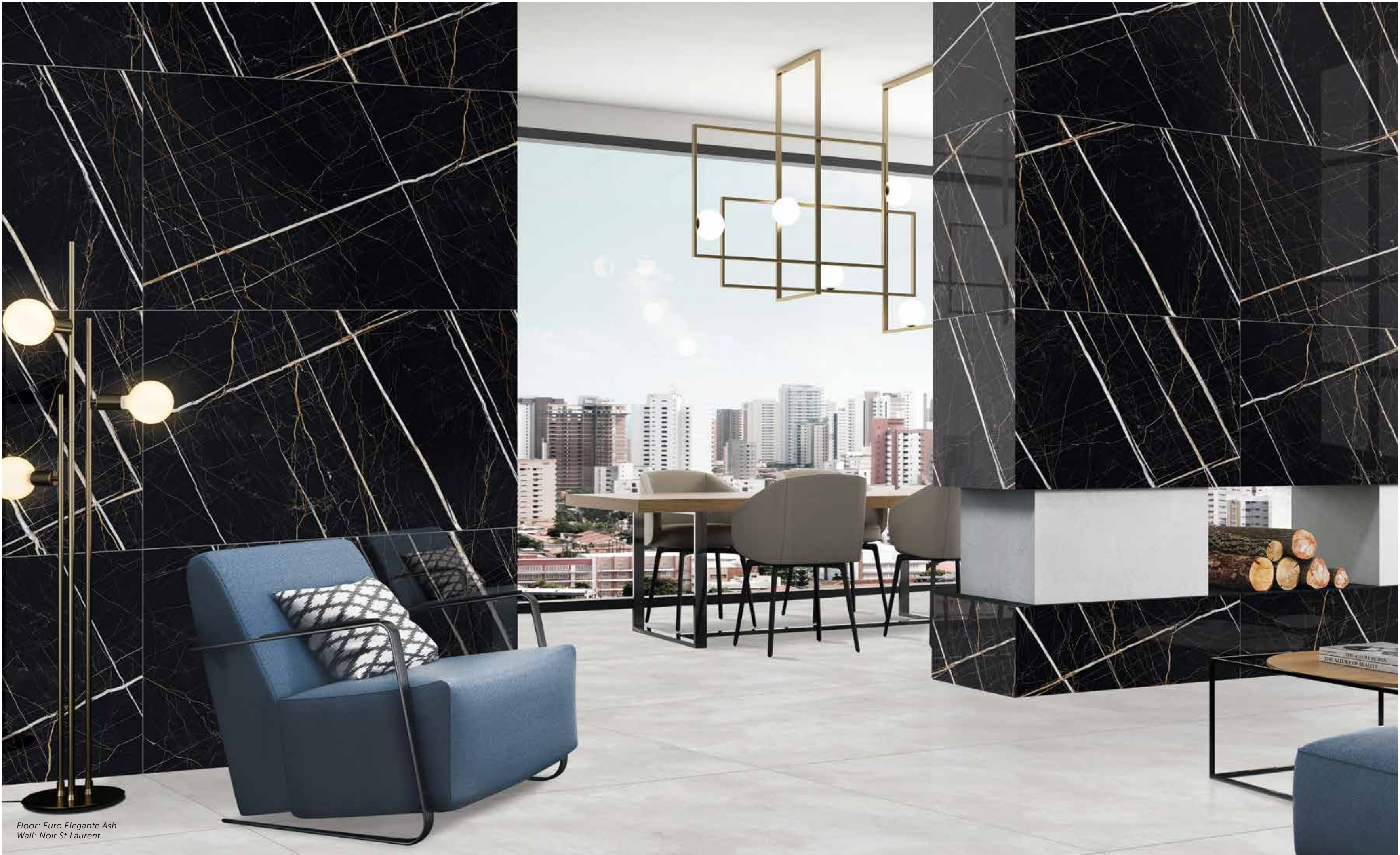

Floor: Euro Elegante Ash
Wall: Noir St Laurent



Floor: Black Emperador

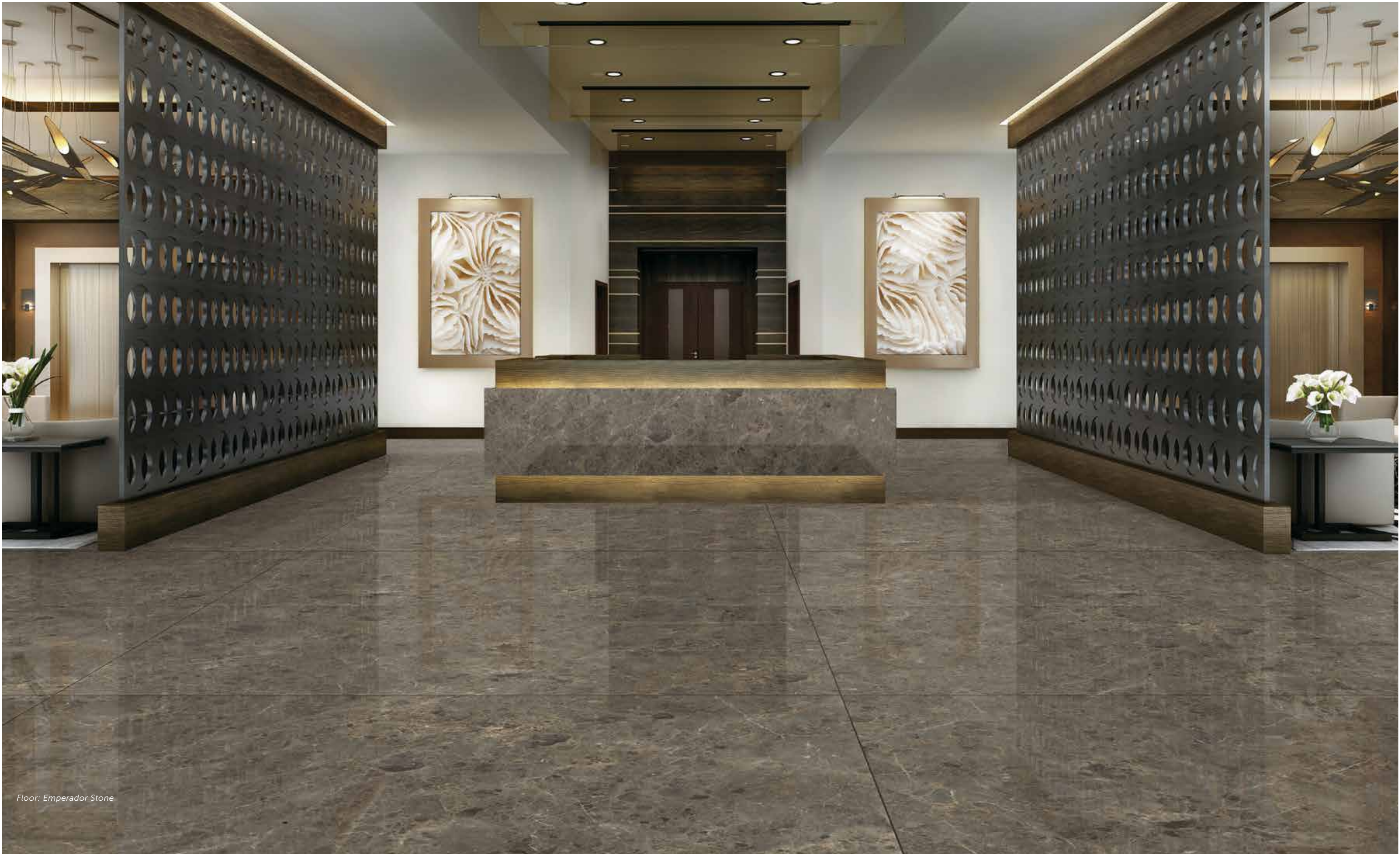

Floor: Emperador Stone



Floor: Silver River



Floor: Botticino Large



Floor: Marfil Beige

MARBLE

ARABESCATO

Vitrified tile
High Glossy



arabescato marble

arabescato marble variations
120x240

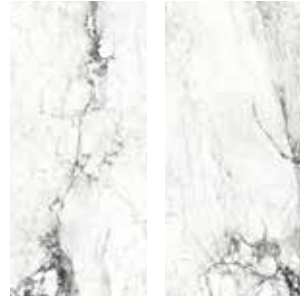

arabescato marble variations
120x120



| ARABESCATO MARBLE | SIZES (cm / inches) | THICKNESS (mm) |
|----------------------|--------------------------|-------------------|
| | 120x240 / 47.24 "x94.5" | 9 |
| | 120x120 / 47.24 "x47.24" | 9 |

Note: For each slab, there will be multiple random faces with different graphic designs of the same genre. For best results of fixing slabs of any size / formats, across any application, please refer to the Maximus Technical Manual in this catalogue. Design images of the product are for illustrative purposes only and may differ in colour and design from the actual product. RAK Ceramics reserves the right to change the colour and the design of any product at its own discretion, without any prior notice.

MARBLE

ARMANI COPPER

Vitrified tile
High Glossy

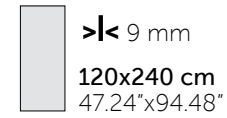

armani copper

armani copper variations
120x240



| ARMANI COPPER | SIZES (cm / inches) | THICKNESS (mm) |
|---------------|-------------------------|-------------------|
| | 120x240 / 47.24 "x94.5" | 9 |

Note: For each slab, there will be multiple random faces with different graphic designs of the same genre. For best results of fixing slabs of any size / formats, across any application, please refer to the Maximus Technical Manual in this catalogue. Design images of the product are for illustrative purposes only and may differ in colour and design from the actual product. RAK Ceramics reserves the right to change the colour and the design of any product at its own discretion, without any prior notice.

MARBLE

ARMANI GOLD

Vitrified tile
High Glossy



9 mm
120x240 cm
47.24"x94.48"



armani gold

armani gold variations
120x240



| ARMANI GOLD | SIZES (cm / inches) | THICKNESS (mm) |
|-------------|-------------------------|-------------------|
| | 120x240 / 47.24"x94.48" | 9 |

Note: For each slab, there will be multiple random faces with different graphic designs of the same genre. For best results of fixing slabs of any size / formats, across any application, please refer to the Maximus Technical Manual in this catalogue. Design images of the product are for illustrative purposes only and may differ in colour and design from the actual product. RAK Ceramics reserves the right to change the colour and the design of any product at its own discretion, without any prior notice.

MARBLE

BLACK BEAUTY

Vitrified tile
High Glossy



9 mm
120x240 cm
47.24"x94.48"



black beauty

black beauty variations
120x240



| BLACK BEAUTY | SIZES (cm / inches) | THICKNESS (mm) |
|--------------|-------------------------|-------------------|
| | 120x240 / 47.24 "x94.5" | 9 |

Note: For each slab, there will be multiple random faces with different graphic designs of the same genre. For best results of fixing slabs of any size / formats, across any application, please refer to the Maximus Technical Manual in this catalogue. Design images of the product are for illustrative purposes only and may differ in colour and design from the actual product. RAK Ceramics reserves the right to change the colour and the design of any product at its own discretion, without any prior notice.

MARBLE

BLACK EMPERADOR

Vitrified tile
High Glossy



9 mm
120x240 cm
47.24"x94.48"



black emperador

black emperador variations
120x240

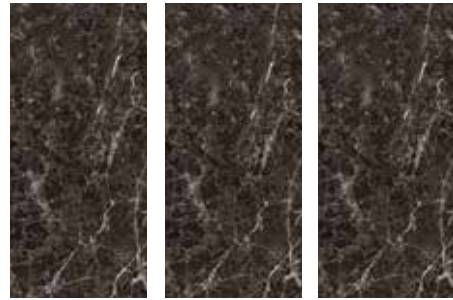

| BLACK EMPERADOR | SIZES (cm / inches) | THICKNESS (mm) |
|-----------------|-------------------------|-------------------|
| | 120x240 / 47.24 "x94.5" | 9 |

Note: For each slab, there will be multiple random faces with different graphic designs of the same genre. For best results of fixing slabs of any size / formats, across any application, please refer to the Maximus Technical Manual in this catalogue. Design images of the product are for illustrative purposes only and may differ in colour and design from the actual product. RAK Ceramics reserves the right to change the colour and the design of any product at its own discretion, without any prior notice.

MARBLE

BLACK GOLD

Vitrified tile
High Glossy



9 mm 9 mm
120x240 cm 120x120 cm
47.24"x94.48" 47.24"x47.24"



black gold

black gold variations
120x240

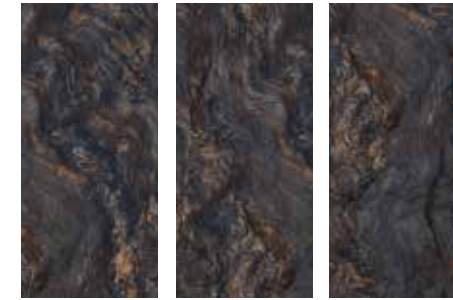

black gold variations
120x120

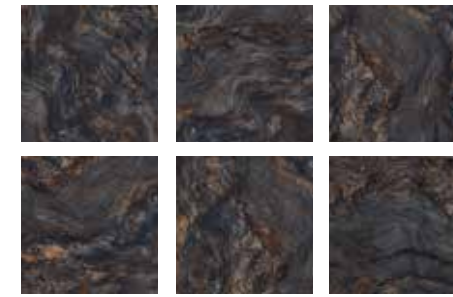

| BLACK GOLD | SIZES (cm / inches) | THICKNESS (mm) |
|-------------------------|-------------------------|-------------------|
| | 120x240 / 47.24 "x94.5" | 9 |
| 120x120 / 47.24"x47.24" | 9 | |

Note: For each slab, there will be multiple random faces with different graphic designs of the same genre. For best results of fixing slabs of any size / formats, across any application, please refer to the Maximus Technical Manual in this catalogue. Design images of the product are for illustrative purposes only and may differ in colour and design from the actual product. RAK Ceramics reserves the right to change the colour and the design of any product at its own discretion, without any prior notice.

MARBLE

BLUEDEL BELGIO BLUE

Vitrified tile
High Glossy



9 mm
120x240 cm
47.24"x94.48"



bluedel belgio blue

bluedel belgio blue variations
120x240



| BLUEDEL BELGIO BLUE | SIZES (cm / inches) | THICKNESS (mm) |
|---------------------|-------------------------|-------------------|
| | 120x240 / 47.24 "x94.5" | 9 |

Note: For each slab, there will be multiple random faces with different graphic designs of the same genre. For best results of fixing slabs of any size / formats, across any application, please refer to the Maximus Technical Manual in this catalogue. Design images of the product are for illustrative purposes only and may differ in colour and design from the actual product. RAK Ceramics reserves the right to change the colour and the design of any product at its own discretion, without any prior notice.

MARBLE

BLUEDEL BELGIO CLAY

Vitrified tile
High Glossy



9 mm 9 mm
120x240 cm 120x120 cm
47.24"x94.48" 47.24"x47.24"

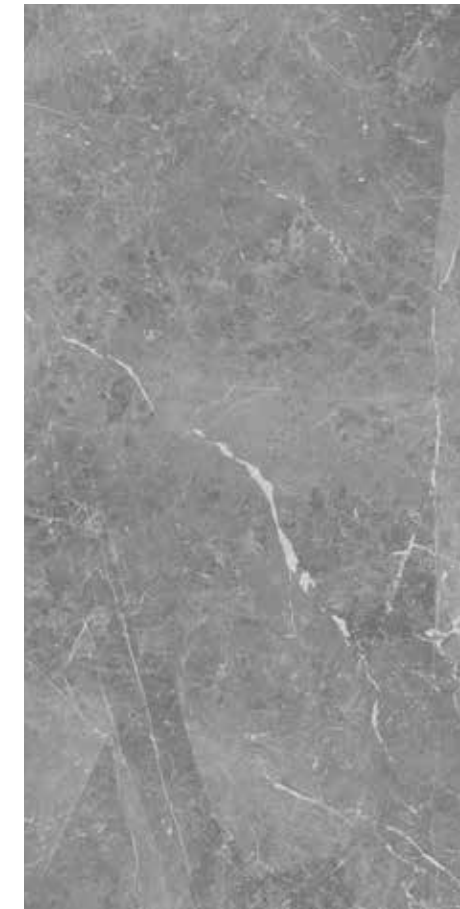

bluedel belgio clay

bluedel belgio clay variations
120x240

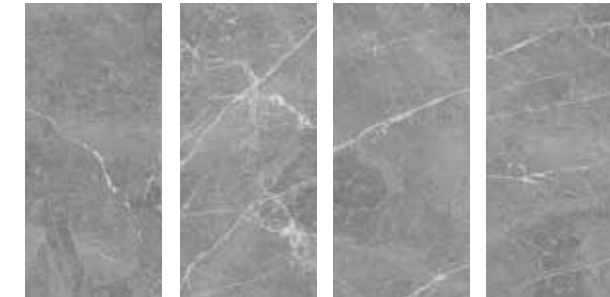

bluedel belgio clay variations
120x120

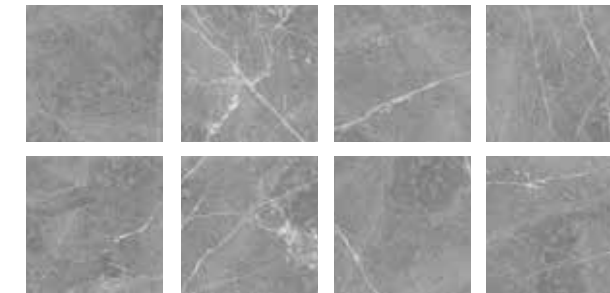

| BLUEDEL BELGIO CLAY | SIZES (cm / inches) | THICKNESS (mm) |
|-------------------------|-------------------------|-------------------|
| | 120x240 / 47.24 "x94.5" | 9 |
| 120x120 / 47.24"x47.24" | 9 | |

Note: For each slab, there will be multiple random faces with different graphic designs of the same genre. For best results of fixing slabs of any size / formats, across any application, please refer to the Maximus Technical Manual in this catalogue. Design images of the product are for illustrative purposes only and may differ in colour and design from the actual product. RAK Ceramics reserves the right to change the colour and the design of any product at its own discretion, without any prior notice.

MARBLE

GREAT EMPERADOR

Vitrified tile
High Glossy



9 mm
120x240 cm
47.24"x94.48"



great emperador variations
120x240

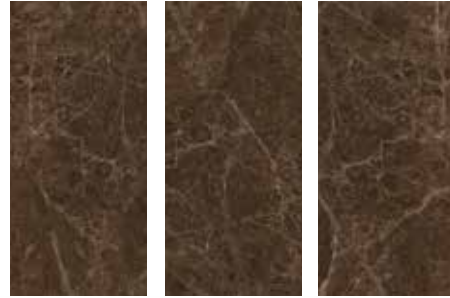

great emperador

| GREAT EMPERADOR | SIZES (cm / inches) | THICKNESS (mm) |
|-----------------|-------------------------|-------------------|
| | 120x240 / 47.24 "x94.5" | 9 |

Note: For each slab, there will be multiple random faces with different graphic designs of the same genre. For best results of fixing slabs of any size / formats, across any application, please refer to the Maximus Technical Manual in this catalogue. Design images of the product are for illustrative purposes only and may differ in colour and design from the actual product. RAK Ceramics reserves the right to change the colour and the design of any product at its own discretion, without any prior notice.

MARBLE

EMPERADOR STONE

Vitrified tile
High Glossy



9 mm
120x240 cm
47.24"x94.48"



emperador stone variations
120x240

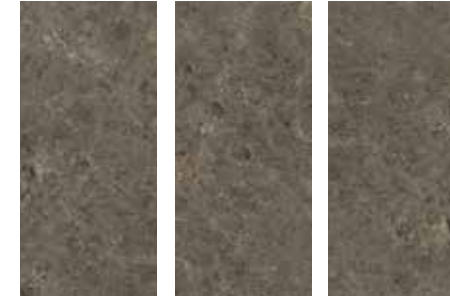

emperador stone

| EMPERADOR STONE | SIZES (cm / inches) | THICKNESS (mm) |
|-----------------|-------------------------|-------------------|
| | 120x240 / 47.24 "x94.5" | 9 |

Note: For each slab, there will be multiple random faces with different graphic designs of the same genre. For best results of fixing slabs of any size / formats, across any application, please refer to the Maximus Technical Manual in this catalogue. Design images of the product are for illustrative purposes only and may differ in colour and design from the actual product. RAK Ceramics reserves the right to change the colour and the design of any product at its own discretion, without any prior notice.

MARBLE

FLURRY GREY

Vitrified tile
High Glossy



9 mm
120x240 cm
47.24"x94.48"



flurry grey black

flurry grey variations
120x240



| FLURRY GREY | SIZES (cm / inches) | THICKNESS (mm) |
|-------------|-------------------------|-------------------|
| | 120x240 / 47.24 "x94.5" | 9 |

Note: For each slab, there will be multiple random faces with different graphic designs of the same genre. For best results of fixing slabs of any size / formats, across any application, please refer to the Maximus Technical Manual in this catalogue. Design images of the product are for illustrative purposes only and may differ in colour and design from the actual product. RAK Ceramics reserves the right to change the colour and the design of any product at its own discretion, without any prior notice.

MARBLE

GRANA PORTORO

Vitrified tile
High Glossy



9 mm
120x240 cm
47.24"x94.48"



grana portoro

grana portoro variations
120x240

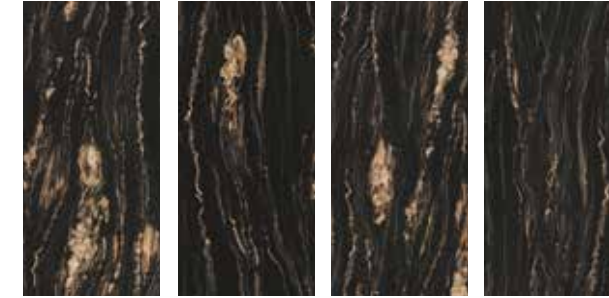

| GRANA PORTORO | SIZES (cm / inches) | THICKNESS (mm) |
|---------------|-------------------------|-------------------|
| | 120x240 / 47.24 "x94.5" | 9 |

Note: For each slab, there will be multiple random faces with different graphic designs of the same genre. For best results of fixing slabs of any size / formats, across any application, please refer to the Maximus Technical Manual in this catalogue. Design images of the product are for illustrative purposes only and may differ in colour and design from the actual product. RAK Ceramics reserves the right to change the colour and the design of any product at its own discretion, without any prior notice.

MARBLE

ELLE MARBLE BLACK

Vitrified tile
High Glossy

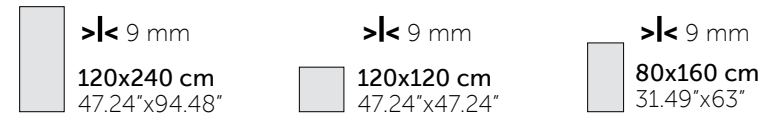

elle marble black

elle marble black variations
120x240 & 80x160

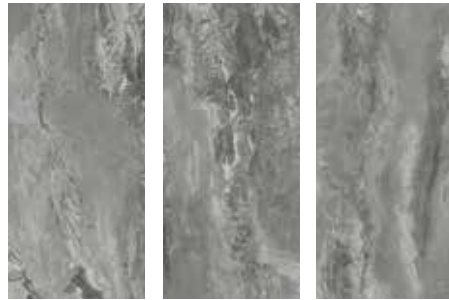

elle marble black variations
120x120

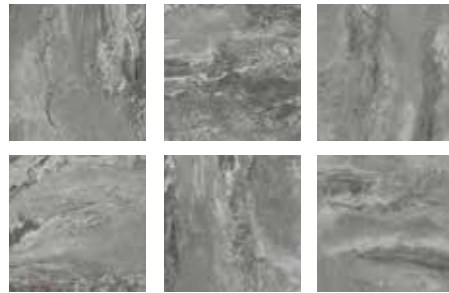

| | SIZES (cm / inches) | THICKNESS (mm) |
|-------------------|-------------------------|-------------------|
| ELLE MARBLE BLACK | 120x240 / 47.24 "x94.5" | 9 |
| | 120x120 / 47.24"x47.24" | 9 |
| | 80x160 / 31.49 "x63" | 9 |

Note: For each slab, there will be multiple random faces with different graphic designs of the same genre. For best results of fixing slabs of any size / formats, across any application, please refer to the Maximus Technical Manual in this catalogue. Design images of the product are for illustrative purposes only and may differ in colour and design from the actual product. RAK Ceramics reserves the right to change the colour and the design of any product at its own discretion, without any prior notice.

MARBLE

MARQUINA BLACK

Vitrified tile
High Glossy

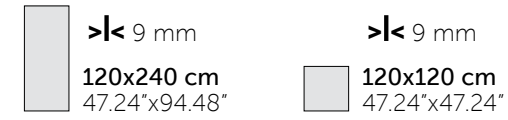

marquina black

marquina black variations
120x240

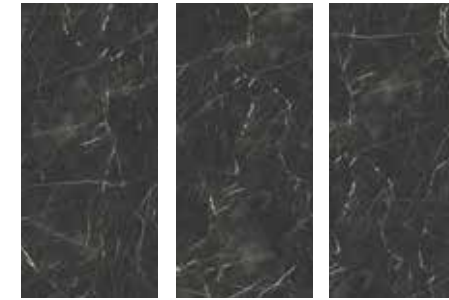

marquina black variations
120x120

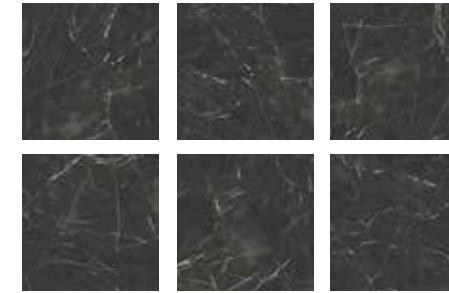

| | SIZES (cm / inches) | THICKNESS (mm) |
|----------------|-------------------------|-------------------|
| MARQUINA BLACK | 120x240 / 47.24 "x94.5" | 9 |
| | 120x120 / 47.24"x47.24" | 9 |

Note: For each slab, there will be multiple random faces with different graphic designs of the same genre. For best results of fixing slabs of any size / formats, across any application, please refer to the Maximus Technical Manual in this catalogue. Design images of the product are for illustrative purposes only and may differ in colour and design from the actual product. RAK Ceramics reserves the right to change the colour and the design of any product at its own discretion, without any prior notice.

MARBLE

ONYX WHITE

Vitrified tile
High Glossy



 **>|< 9 mm**
120x240 cm
 47.24"x94.48"

 **>|< 9 mm**
120x120 cm
 47.24"x47.24"



onyx white

onyx white variations
120x240

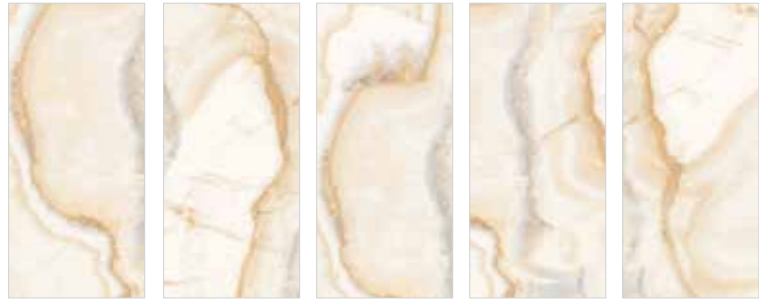

onyx white variations
120x120



| | SIZES (cm / inches) | THICKNESS (mm) |
|------------|-------------------------|-------------------|
| ONYX WHITE | 120x240 / 47.24 "x94.5" | 9 |
| | 120x120 / 47.24"x47.24" | 9 |

Note: For each slab, there will be multiple random faces with different graphic designs of the same genre. For best results of fixing slabs of any size / formats, across any application, please refer to the Maximus Technical Manual in this catalogue. Design images of the product are for illustrative purposes only and may differ in colour and design from the actual product. RAK Ceramics reserves the right to change the colour and the design of any product at its own discretion, without any prior notice.

MARBLE

POLISHED BROWN

Vitrified tile
High Glossy



 **>|< 9 mm**
120x120 cm
 47.24"x47.24"



polished brown

polished brown variations
120x120



| MARMİ SILICA DBR | SIZES (cm / inches) | THICKNESS (mm) |
|------------------|-------------------------|-------------------|
| | 120x120 / 47.24"x47.24" | 9 |

MARMİ SILICA DBR



marmi silica dbr

marmi silica dbr variations
120x120



| MARMİ SILICA DBR | SIZES (cm / inches) | THICKNESS (mm) |
|------------------|-------------------------|-------------------|
| | 120x120 / 47.24"x47.24" | 9 |



Note: For each slab, there will be multiple random faces with different graphic designs of the same genre. For best results of fixing slabs of any size / formats, across any application, please refer to the Maximus Technical Manual in this catalogue. Design images of the product are for illustrative purposes only and may differ in colour and design from the actual product. RAK Ceramics reserves the right to change the colour and the design of any product at its own discretion, without any prior notice.

MARBLE

REGAL BEIGE

Vitrified tile
High Glossy | Polished | Baby skin



9 mm
120x240 cm
47.24"x94.48"

9 mm
80x160 cm
31.49"x63"



regal beige

regal beige variations
120x240 and 80x160



Baby Skin Available in 80x160 only

| REGAL BEIGE | SIZES (cm / inches) | THICKNESS (mm) |
|----------------------|-------------------------|-------------------|
| | 120x240 / 47.24 "x94.5" | 9 |
| 80x160 / 31.49 "x63" | 9 | |

Note: For each slab, there will be multiple random faces with different graphic designs of the same genre. For best results of fixing slabs of any size / formats, across any application, please refer to the Maximus Technical Manual in this catalogue. Design images of the product are for illustrative purposes only and may differ in colour and design from the actual product. RAK Ceramics reserves the right to change the colour and the design of any product at its own discretion, without any prior notice.

MARBLE

ROLEX GREY

Vitrified tile
High Glossy



9 mm
120x240 cm
47.24"x94.48"



rolex grey

rolex grey variations
120x240

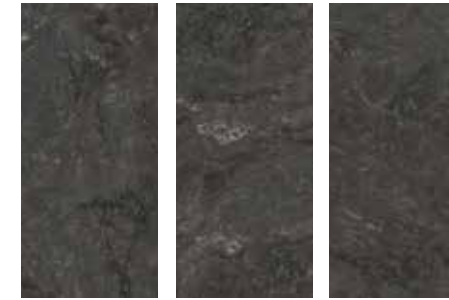

| ROLEX GREY | SIZES (cm / inches) | THICKNESS (mm) |
|------------|-------------------------|-------------------|
| | 120x240 / 47.24 "x94.5" | 9 |

Note: For each slab, there will be multiple random faces with different graphic designs of the same genre. For best results of fixing slabs of any size / formats, across any application, please refer to the Maximus Technical Manual in this catalogue. Design images of the product are for illustrative purposes only and may differ in colour and design from the actual product. RAK Ceramics reserves the right to change the colour and the design of any product at its own discretion, without any prior notice.

MARBLE

SILK MARBLE GREY

Vitrified tile
High Glossy



silk marble grey

silk marble grey variations
120x240



silk marble grey variations
120x120



| SILK MARBLE GREY | SIZES (cm / inches) | THICKNESS (mm) |
|-------------------------|------------------------|-------------------|
| | 120x240 / 47.24"x94.5" | 9 |
| 120x120 / 47.24"x47.24" | 9 | |

Note: For each slab, there will be multiple random faces with different graphic designs of the same genre. For best results of fixing slabs of any size / formats, across any application, please refer to the Maximus Technical Manual in this catalogue. Design images of the product are for illustrative purposes only and may differ in colour and design from the actual product. RAK Ceramics reserves the right to change the colour and the design of any product at its own discretion, without any prior notice.



Floor: Silk Marble Grey
Wall: Silk Marble Grey

MARBLE

SILVER RIVER

Vitrified tile
High Glossy

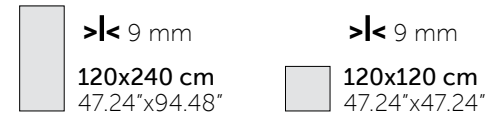

silver river

silver river variations
120x240, 90x180 & 80x160



silver river variations
120x120



| | SIZES (cm / inches) | THICKNESS (mm) |
|--------------|-------------------------|-------------------|
| SILVER RIVER | 120x240 / 47.24 "x94.5" | 9 |
| | 120x120 / 47.24"x47.24" | 9 |
| | 80x160 / 31.49 "x63" | 9 |

Note: For each slab, there will be multiple random faces with different graphic designs of the same genre. For best results of fixing slabs of any size / formats, across any application, please refer to the Maximus Technical Manual in this catalogue. Design images of the product are for illustrative purposes only and may differ in colour and design from the actual product. RAK Ceramics reserves the right to change the colour and the design of any product at its own discretion, without any prior notice.

MARBLE

BOTTICINO LARGE

Vitrified tile
Polished



botticino large

botticino large variations
120x240 & 80x160



botticino large variations
120x120

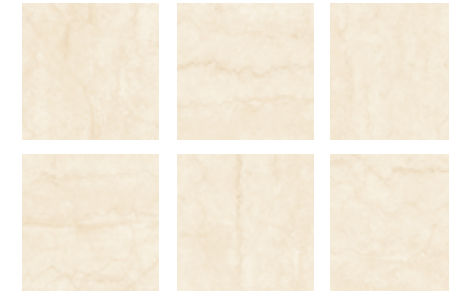

Baby Skin Available in 80x160 only

| | SIZES (cm / inches) | THICKNESS (mm) |
|-----------------|-------------------------|-------------------|
| BOTTICINO LARGE | 120x240 / 47.24 "x94.5" | 9 |
| | 120x120 / 47.24"x47.24" | 9 |
| | 80x160 / 31.49 "x63" | 9 |

Note: For each slab, there will be multiple random faces with different graphic designs of the same genre. For best results of fixing slabs of any size / formats, across any application, please refer to the Maximus Technical Manual in this catalogue. Design images of the product are for illustrative purposes only and may differ in colour and design from the actual product. RAK Ceramics reserves the right to change the colour and the design of any product at its own discretion, without any prior notice.

MARBLE

BRECCIA AURORA

Vitrified tile
Polished



>|< 9 mm
120x240 cm
47.24"x94.48"

>|< 9 mm
120x120 cm
47.24"x47.24"

>|< 9 mm
80x160 cm
31.49"x63"



breccia aurora

breccia aurora variations
120x240 & 80x160



breccia aurora variations
120x120



| | SIZES (cm / inches) | THICKNESS (mm) |
|----------------|-------------------------|-------------------|
| BRECCIA AURORA | 120x240 / 47.24 "x94.5" | 9 |
| | 120x120 / 47.24"x47.24" | 9 |
| | 80x160 / 31.49 "x63" | 9 |

Note: For each slab, there will be multiple random faces with different graphic designs of the same genre. For best results of fixing slabs of any size / formats, across any application, please refer to the Maximus Technical Manual in this catalogue. Design images of the product are for illustrative purposes only and may differ in colour and design from the actual product. RAK Ceramics reserves the right to change the colour and the design of any product at its own discretion, without any prior notice.

MARBLE

STATUARIO SILK

Vitrified tile
Polished | Baby Skin



>|< 9 mm
120x240 cm
47.24"x94.48"

>|< 9 mm
80x160 cm
31.49"x63"



statuario silk

statuario silk variations
120x240 & 80x160

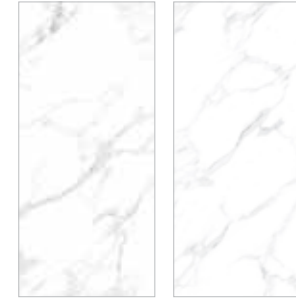

Baby Skin Available in 80x160 only

| | SIZES (cm / inches) | THICKNESS (mm) |
|----------------|-------------------------|-------------------|
| STATUARIO SILK | 120x240 / 47.24 "x94.5" | 9 |
| | 80x160 / 31.49 "x63" | 9 |

Note: For each slab, there will be multiple random faces with different graphic designs of the same genre. For best results of fixing slabs of any size / formats, across any application, please refer to the Maximus Technical Manual in this catalogue. Design images of the product are for illustrative purposes only and may differ in colour and design from the actual product. RAK Ceramics reserves the right to change the colour and the design of any product at its own discretion, without any prior notice.

MARBLE

CARARA GOLD

Vitrified tile
Polished



>|< 9 mm
80x160 cm
31.49"x63"

>|< 9 mm
120x120 cm
47.24"x47.24"



carara gold

carara gold variations
80x160

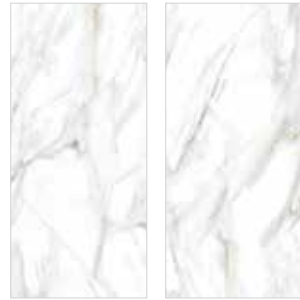

carara gold variations
120x120



| | SIZES (cm / inches) | THICKNESS (mm) |
|-------------|-------------------------|-------------------|
| CARARA GOLD | 80x160 / 31.49 "x63" | 9 |
| | 120x120 / 47.24"x47.24" | 9 |

Note: For each slab, there will be multiple random faces with different graphic designs of the same genre. For best results of fixing slabs of any size / formats, across any application, please refer to the Maximus Technical Manual in this catalogue. Design images of the product are for illustrative purposes only and may differ in colour and design from the actual product. RAK Ceramics reserves the right to change the colour and the design of any product at its own discretion, without any prior notice.

MARBLE

CARARA GREY

Vitrified tile
Polished



>|< 9 mm
120x240 cm
47.24"x94.48"

>|< 9 mm
120x120 cm
47.24"x47.24"



carara grey

carara grey variations
120x240

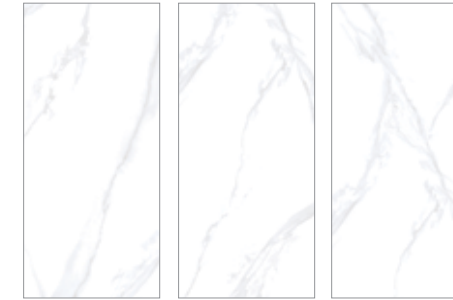

carara grey variations
120x120

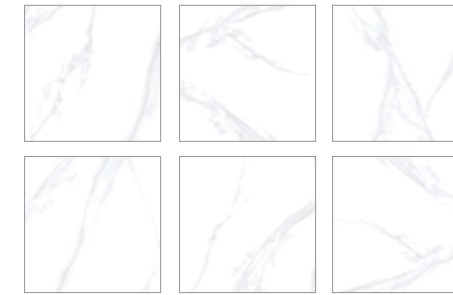

| | SIZES (cm / inches) | THICKNESS (mm) |
|-------------|-------------------------|-------------------|
| CARARA GREY | 120x240 / 47.24 "x94.5" | 9 |
| | 120x120 / 47.24"x47.24" | 9 |

Note: For each slab, there will be multiple random faces with different graphic designs of the same genre. For best results of fixing slabs of any size / formats, across any application, please refer to the Maximus Technical Manual in this catalogue. Design images of the product are for illustrative purposes only and may differ in colour and design from the actual product. RAK Ceramics reserves the right to change the colour and the design of any product at its own discretion, without any prior notice.

MARBLE

CLASSIC BEIGE

Vitrified tile
Polished



>|< 9 mm
120x120 cm
47.24"x47.24"

>|< 9 mm
80x160 cm
31.49"x63"



classic beige

classic beige variations
80x160



classic beige variations
120x120



| | SIZES (cm / inches) | THICKNESS (mm) |
|---------------|-------------------------|-------------------|
| CLASSIC BEIGE | 120x120 / 47.24"x47.24" | 9 |
| | 80x160 / 31.49 "x63" | 9 |

Note: For each slab, there will be multiple random faces with different graphic designs of the same genre. For best results of fixing slabs of any size / formats, across any application, please refer to the Maximus Technical Manual in this catalogue. Design images of the product are for illustrative purposes only and may differ in colour and design from the actual product. RAK Ceramics reserves the right to change the colour and the design of any product at its own discretion, without any prior notice.

MARBLE

FIORITO BEIGE

Vitrified tile
Polished



>|< 9 mm
120x240 cm
47.24"x94.48"

>|< 9 mm
120x120 cm
47.24"x47.24"

>|< 9 mm
80x160 cm
31.49"x63"



fiorito beige

fiorito beige variations
120x240 & 80x160



fiorito beige variations
120x120



Baby Skin Available in 80x160 only

| | SIZES (cm / inches) | THICKNESS (mm) |
|---------------|-------------------------|-------------------|
| FIORITO BEIGE | 120x240 / 47.24 "x94.5" | 9 |
| | 120x120 / 47.24"x47.24" | 9 |
| | 80x160 / 31.49 "x63" | 9 |

Note: For each slab, there will be multiple random faces with different graphic designs of the same genre. For best results of fixing slabs of any size / formats, across any application, please refer to the Maximus Technical Manual in this catalogue. Design images of the product are for illustrative purposes only and may differ in colour and design from the actual product. RAK Ceramics reserves the right to change the colour and the design of any product at its own discretion, without any prior notice.

MARBLE

GARFAGNANA BM

Vitrified tile
Polished



9 mm
120x240 cm
47.24"x94.48"



garfagnana bm -1

garfagnana bm -2



| GARFAGNANA BM | SIZES (cm / inches) | THICKNESS (mm) |
|---------------|-------------------------|-------------------|
| | 120x240 / 47.24 "x94.5" | 9 |

Note: For each slab, there will be multiple random faces with different graphic designs of the same genre. For best results of fixing slabs of any size / formats, across any application, please refer to the Maximus Technical Manual in this catalogue. Design images of the product are for illustrative purposes only and may differ in colour and design from the actual product. RAK Ceramics reserves the right to change the colour and the design of any product at its own discretion, without any prior notice.

MARBLE

ICE BERG

Vitrified tile
Polished



9 mm 9 mm
120x240 cm 120x120 cm
47.24"x94.48" 47.24"x47.24"



ice berg

ice berg variations
120x240



ice berg variations
120x120

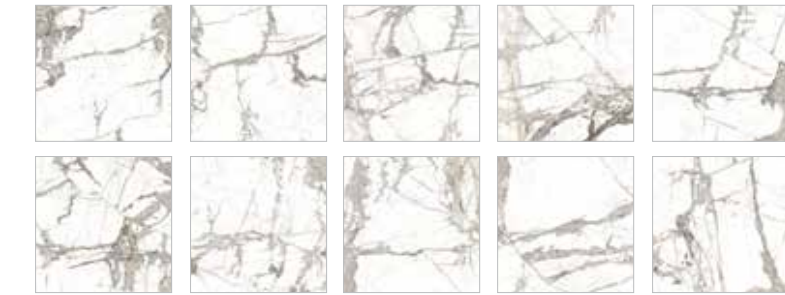

| ICE BERG | SIZES (cm / inches) | THICKNESS (mm) |
|-------------------------|-------------------------|-------------------|
| | 120x240 / 47.24 "x94.5" | 9 |
| 120x120 / 47.24"x47.24" | 9 | |

MARBLE

MARFIL BEIGE

Vitrified tile
Polished



9 mm
120x240 cm
47.24"x94.48"

9 mm
120x120 cm
47.24"x47.24"

9 mm
80x160 cm
31.49"x63"



marfil beige

marfil beige variations
120x240 & 80x160



marfil beige variations
120x120



| | SIZES (cm / inches) | THICKNESS (mm) |
|--------------|-------------------------|-------------------|
| MARFIL BEIGE | 120x240 / 47.24 "x94.5" | 9 |
| | 120x120/ 47.24 "x47.24" | 9 |
| | 80x160 / 31.49 "x63" | 9 |

Note: For each slab, there will be multiple random faces with different graphic designs of the same genre. For best results of fixing slabs of any size / formats, across any application, please refer to the Maximus Technical Manual in this catalogue. Design images of the product are for illustrative purposes only and may differ in colour and design from the actual product. RAK Ceramics reserves the right to change the colour and the design of any product at its own discretion, without any prior notice.

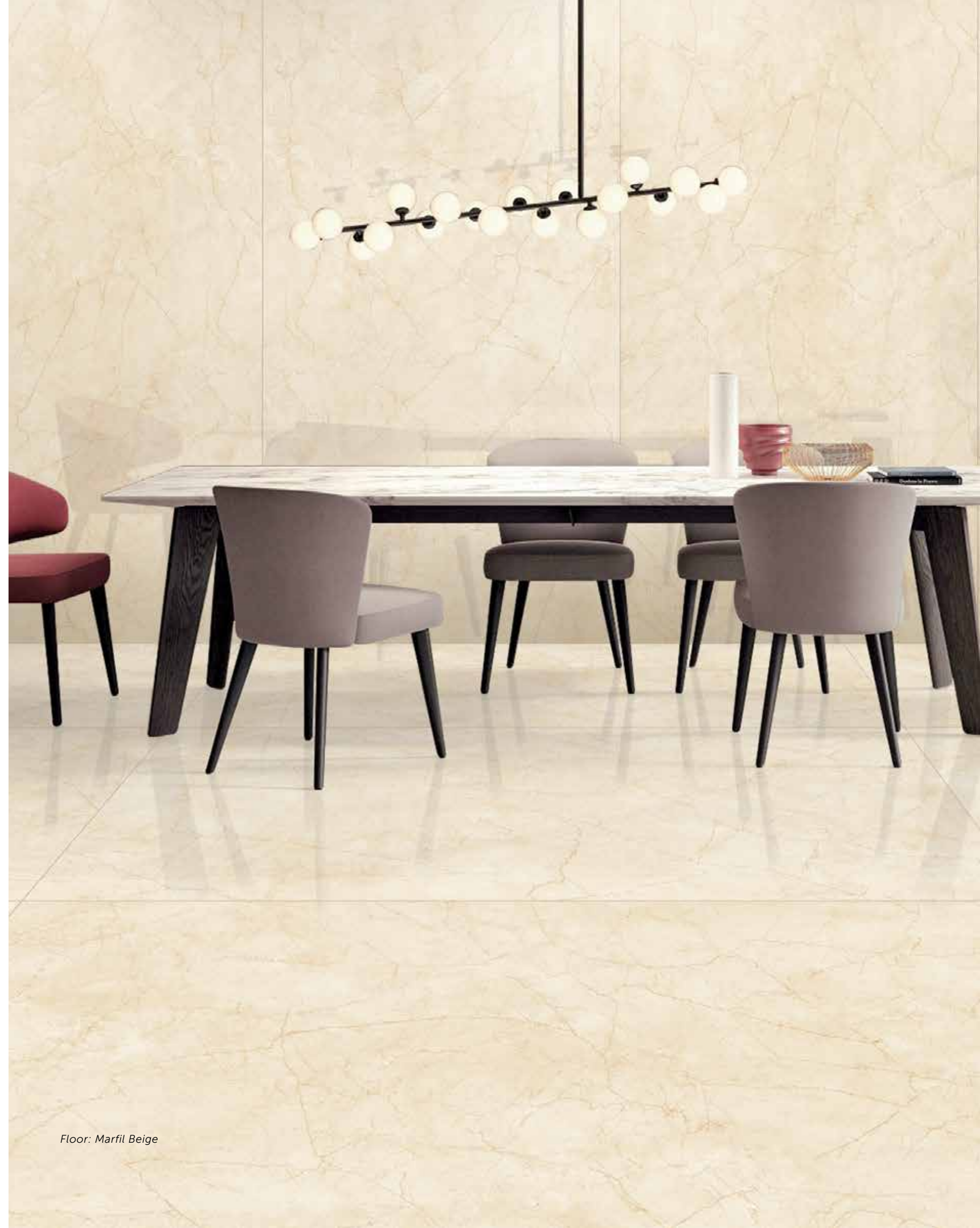

Floor: Marfil Beige

MARBLE

ICE GREY

Vitrified tile
Polished

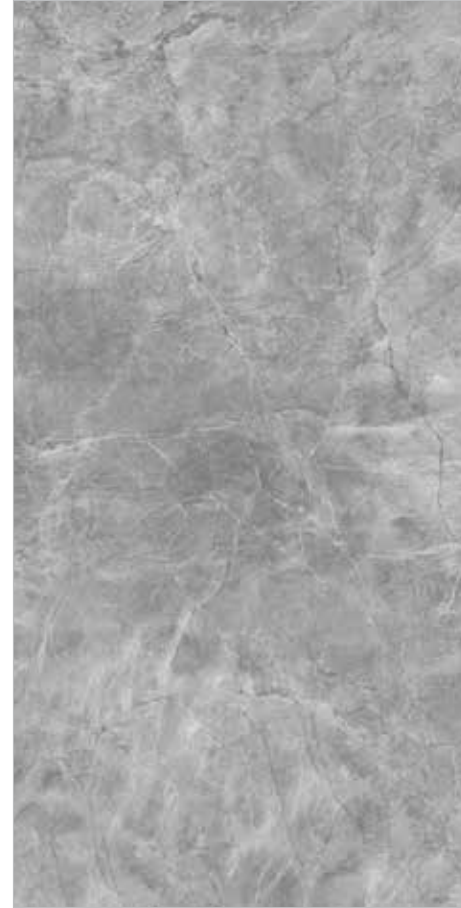

ice grey

ice grey variations
80x160

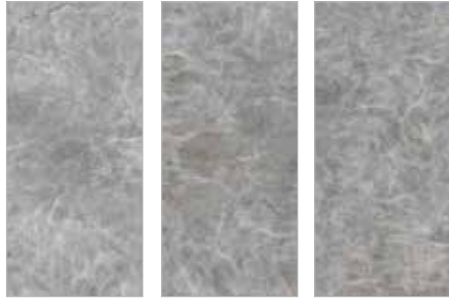

marfil beige variations
120x120

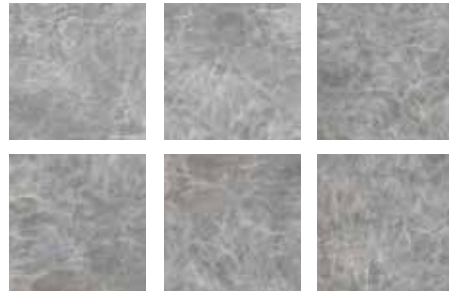

| ICE GREY | SIZES (cm / inches) | THICKNESS (mm) |
|----------|--------------------------|-------------------|
| | 80x160 / 31.49 "x63" | 9 |
| | 120x120 / 47.24 "x47.24" | 9 |

Note: For each slab, there will be multiple random faces with different graphic designs of the same genre. For best results of fixing slabs of any size / formats, across any application, please refer to the Maximus Technical Manual in this catalogue. Design images of the product are for illustrative purposes only and may differ in colour and design from the actual product. RAK Ceramics reserves the right to change the colour and the design of any product at its own discretion, without any prior notice.

MARBLE

MILKY WAY

Vitrified tile
Polished

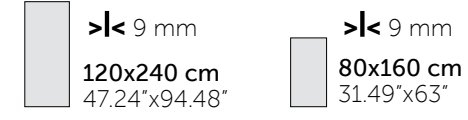

milky way

milky way variations
120x240 & 80x160



| MILKY WAY | SIZES (cm / inches) | THICKNESS (mm) |
|-----------|-------------------------|-------------------|
| | 120x240 / 47.24 "x94.5" | 9 |
| | 80x160 / 31.49 "x63" | 9 |

Note: For each slab, there will be multiple random faces with different graphic designs of the same genre. For best results of fixing slabs of any size / formats, across any application, please refer to the Maximus Technical Manual in this catalogue. Design images of the product are for illustrative purposes only and may differ in colour and design from the actual product. RAK Ceramics reserves the right to change the colour and the design of any product at its own discretion, without any prior notice.

MARBLE

NEW MARFIL BEIGE

Vitrified tile
Polished



 **>|< 9 mm**
120x240 cm
 47.24"x94.48"

 **>|< 9 mm**
120x120 cm
 47.24"x47.24"

 **>|< 9 mm**
80x160 cm
 31.49"x63"



new marfil beige

new marfil beige variations
120x240 & 80x160



new marfil beige variations
120x120



| | SIZES (cm / inches) | THICKNESS (mm) |
|------------------|-------------------------|-------------------|
| NEW MARFIL BEIGE | 120x240 / 47.24 "x94.5" | 9 |
| | 120x120 / 47.24"x47.24" | 9 |
| | 80x160 / 31.49 "x63" | 9 |

Note: For each slab, there will be multiple random faces with different graphic designs of the same genre. For best results of fixing slabs of any size / formats, across any application, please refer to the Maximus Technical Manual in this catalogue. Design images of the product are for illustrative purposes only and may differ in colour and design from the actual product. RAK Ceramics reserves the right to change the colour and the design of any product at its own discretion, without any prior notice.

MARBLE

NEW TRAVERTINO IVORY

Vitrified tile
Polished



 **>|< 9 mm**
120x240 cm
 47.24"x94.48"

 **>|< 9 mm**
80x160 cm
 31.49"x63"



new travertino ivory

new travertino ivory variations
120x240 & 80x160



| | SIZES (cm / inches) | THICKNESS (mm) |
|-------------------------|-------------------------|-------------------|
| NEW TRAVERTINO IVORY | 120x240 / 47.24 "x94.5" | 9 |
| | 80x160 / 31.49 "x63" | 9 |

Note: For each slab, there will be multiple random faces with different graphic designs of the same genre. For best results of fixing slabs of any size / formats, across any application, please refer to the Maximus Technical Manual in this catalogue. Design images of the product are for illustrative purposes only and may differ in colour and design from the actual product. RAK Ceramics reserves the right to change the colour and the design of any product at its own discretion, without any prior notice.

MARBLE

BRUSSA BEIGE

Vitrified tile
Polished



>|< 9 mm
80x160 cm
31.49"x63"

>|< 9 mm
120x120 cm
47.24"x47.24"



brussa beige

brussa beige variations
80x160



brussa beige variations
120x120

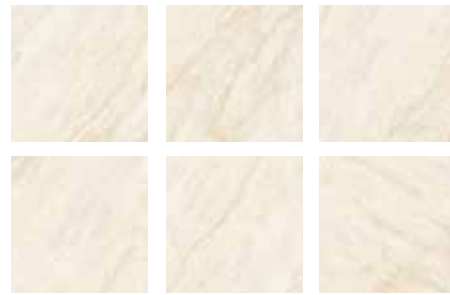

| BRUSSA BEIGE | SIZES (cm / inches) | THICKNESS (mm) |
|--------------|-------------------------|-------------------|
| | 80x160 / 31.49 "x63" | 9 |
| | 120x120 / 47.24"x47.24" | 9 |

Note: For each slab, there will be multiple random faces with different graphic designs of the same genre. For best results of fixing slabs of any size / formats, across any application, please refer to the Maximus Technical Manual in this catalogue. Design images of the product are for illustrative purposes only and may differ in colour and design from the actual product. RAK Ceramics reserves the right to change the colour and the design of any product at its own discretion, without any prior notice.

MARBLE

REAGAN CREMA

Vitrified tile
Polished



>|< 9 mm
80x160 cm
31.49"x63"



reagan crema

reagan crema variations
80x160



| REAGAN CREMA | SIZES (cm / inches) | THICKNESS (mm) |
|--------------|------------------------|-------------------|
| | 80x160 / 31.49 "x63" | 9 |

Note: For each slab, there will be multiple random faces with different graphic designs of the same genre. For best results of fixing slabs of any size / formats, across any application, please refer to the Maximus Technical Manual in this catalogue. Design images of the product are for illustrative purposes only and may differ in colour and design from the actual product. RAK Ceramics reserves the right to change the colour and the design of any product at its own discretion, without any prior notice.

MARBLE

AMANI

Vitrified tile
High Glossy | Baby Skin



9 mm
80x160 cm
31.49"x63"



amani marble light grey

amani marble lgy variations
80x160



| AMANI MARBLE LIGHT GREY | SIZES (cm / inches) | THICKNESS (mm) |
|----------------------------|------------------------|-------------------|
| | 80x160 / 31.49 "x63" | 9 |

Note: For each slab, there will be multiple random faces with different graphic designs of the same genre. For best results of fixing slabs of any size / formats, across any application, please refer to the Maximus Technical Manual in this catalogue. Design images of the product are for illustrative purposes only and may differ in colour and design from the actual product. RAK Ceramics reserves the right to change the colour and the design of any product at its own discretion, without any prior notice.

MARBLE

BRECCIA BROWN

Vitrified tile
High Glossy



9 mm
80x160 cm
31.49"x63"



breccia brown

breccia brown variations
80x160



| BRECCIA BROWN | SIZES (cm / inches) | THICKNESS (mm) |
|---------------|------------------------|-------------------|
| | 80x160 / 31.49 "x63" | 9 |

Note: For each slab, there will be multiple random faces with different graphic designs of the same genre. For best results of fixing slabs of any size / formats, across any application, please refer to the Maximus Technical Manual in this catalogue. Design images of the product are for illustrative purposes only and may differ in colour and design from the actual product. RAK Ceramics reserves the right to change the colour and the design of any product at its own discretion, without any prior notice.

MARBLE

DARK EMPERADOR

Vitrified tile
High Glossy



>|< 9 mm
80x160 cm
31.49"x63"

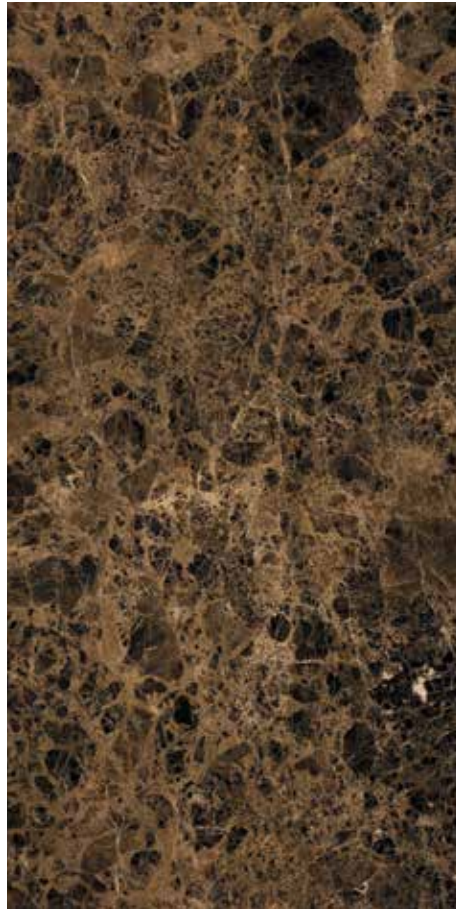

dark emperador

dark emperador variations
80x160

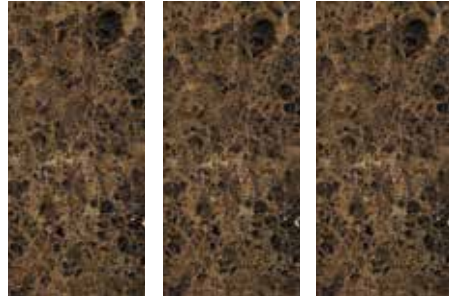

| DARK EMPERADOR | SIZES (cm / inches) | THICKNESS (mm) |
|----------------|------------------------|-------------------|
| | 80x160 / 31.49 "x63" | 9 |

Note: For each slab, there will be multiple random faces with different graphic designs of the same genre. For best results of fixing slabs of any size / formats, across any application, please refer to the Maximus Technical Manual in this catalogue. Design images of the product are for illustrative purposes only and may differ in colour and design from the actual product. RAK Ceramics reserves the right to change the colour and the design of any product at its own discretion, without any prior notice.

MARBLE

NOIR ST LAURENT

Vitrified tile
High Glossy



>|< 9 mm
80x160 cm
31.49"x63"

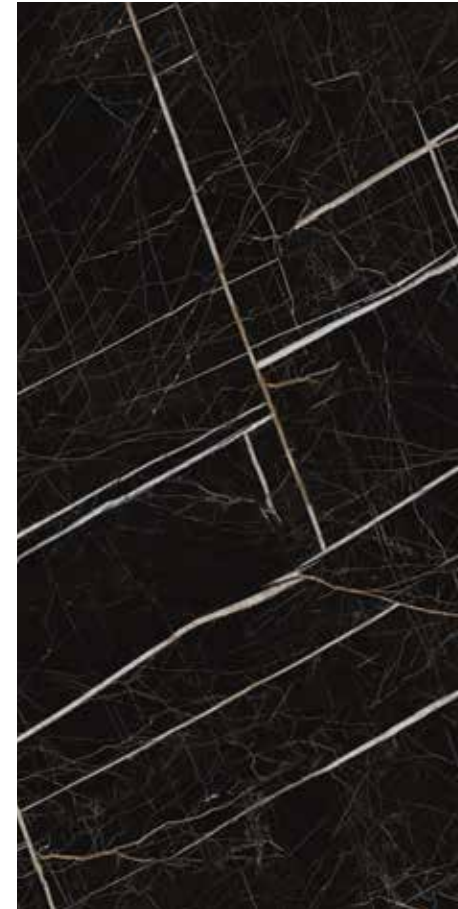

noir st laurent

noir st laurent variations
80x160

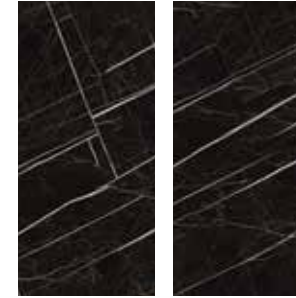

| NOIR ST LAURENT | SIZES (cm / inches) | THICKNESS (mm) |
|-----------------|------------------------|-------------------|
| | 80x160 / 31.49 "x63" | 9 |

Note: For each slab, there will be multiple random faces with different graphic designs of the same genre. For best results of fixing slabs of any size / formats, across any application, please refer to the Maximus Technical Manual in this catalogue. Design images of the product are for illustrative purposes only and may differ in colour and design from the actual product. RAK Ceramics reserves the right to change the colour and the design of any product at its own discretion, without any prior notice.

MARBLE

ANTIQUÉ BEIGE

Vitrified tile
Polished



> 9 mm
80x160 cm
31.49"x63"



antique beige

antique beige variations
80x160



| ANTIQUÉ BEIGE | SIZES (cm / inches) | THICKNESS (mm) |
|---------------|------------------------|-------------------|
| | 80x160 / 31.49 "x63" | 9 |

MARBLE

DYNA

Vitrified tile
Polished



> 9 mm
80x160 cm
31.49"x63"



dyna

dyna variations
80x160



| DYNA | SIZES (cm / inches) | THICKNESS (mm) |
|------|------------------------|-------------------|
| | 80x160 / 31.49 "x63" | 9 |

Note: For each slab, there will be multiple random faces with different graphic designs of the same genre. For best results of fixing slabs of any size / formats, across any application, please refer to the Maximus Technical Manual in this catalogue. Design images of the product are for illustrative purposes only and may differ in colour and design from the actual product. RAK Ceramics reserves the right to change the colour and the design of any product at its own discretion, without any prior notice.

MARBLE

GARFAGNANA

Vitrified tile
Polished



>|< 9 mm
80x160 cm
31.49"x63"

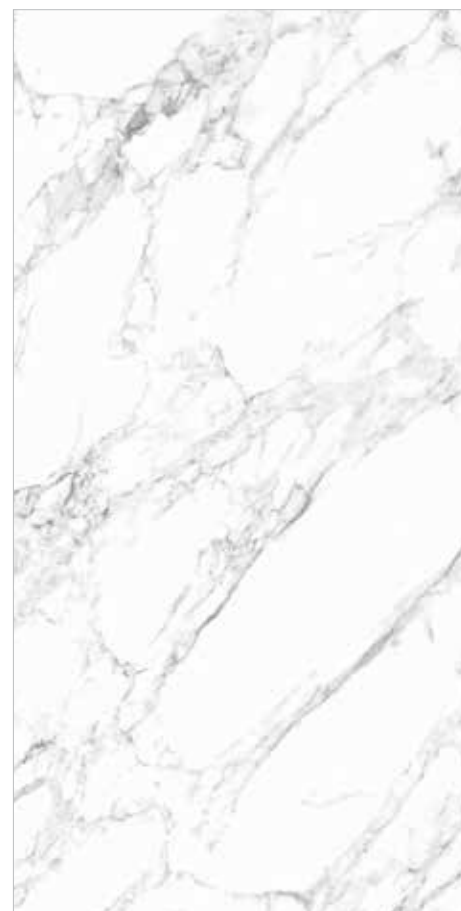

garfagnana

garfagnana variations
80x160



| GARFAGNANA | SIZES (cm / inches) | THICKNESS (mm) |
|------------|------------------------|-------------------|
| | 80x160 / 31.49 "x63" | 9 |

Note: For each slab, there will be multiple random faces with different graphic designs of the same genre. For best results of fixing slabs of any size / formats, across any application, please refer to the Maximus Technical Manual in this catalogue. Design images of the product are for illustrative purposes only and may differ in colour and design from the actual product. RAK Ceramics reserves the right to change the colour and the design of any product at its own discretion, without any prior notice.

MARBLE

LAWRANCE GREY

Vitrified tile
Polished



>|< 9 mm
80x160 cm
31.49"x63"



lawrance grey

lawrance grey variations
80x160



| LAWRANCE GREY | SIZES (cm / inches) | THICKNESS (mm) |
|---------------|------------------------|-------------------|
| | 80x160 / 31.49 "x63" | 9 |

Note: For each slab, there will be multiple random faces with different graphic designs of the same genre. For best results of fixing slabs of any size / formats, across any application, please refer to the Maximus Technical Manual in this catalogue. Design images of the product are for illustrative purposes only and may differ in colour and design from the actual product. RAK Ceramics reserves the right to change the colour and the design of any product at its own discretion, without any prior notice.

MARBLE

MONTANA BEIGE

Vitrified tile
Polished



>|< 9 mm
80x160 cm
31.49"x63"



montana beige

montana beige variations
80x160



| MONTANA BEIGE | SIZES (cm / inches) | THICKNESS (mm) |
|---------------|------------------------|-------------------|
| | 80x160 / 31.49 "x63" | 9 |

Note: For each slab, there will be multiple random faces with different graphic designs of the same genre. For best results of fixing slabs of any size / formats, across any application, please refer to the Maximus Technical Manual in this catalogue. Design images of the product are for illustrative purposes only and may differ in colour and design from the actual product. RAK Ceramics reserves the right to change the colour and the design of any product at its own discretion, without any prior notice.

MARBLE

TRAVERTINO LIGHT BEIGE

Vitrified tile
Polished



>|< 9 mm
80x160 cm
31.49"x63"



travertino light beige

travertino light beige variations
80x160



| TRAVERTINO LIGHT BEIGE | SIZES (cm / inches) | THICKNESS (mm) |
|------------------------|------------------------|-------------------|
| | 80x160 / 31.49 "x63" | 9 |

Note: For each slab, there will be multiple random faces with different graphic designs of the same genre. For best results of fixing slabs of any size / formats, across any application, please refer to the Maximus Technical Manual in this catalogue. Design images of the product are for illustrative purposes only and may differ in colour and design from the actual product. RAK Ceramics reserves the right to change the colour and the design of any product at its own discretion, without any prior notice.

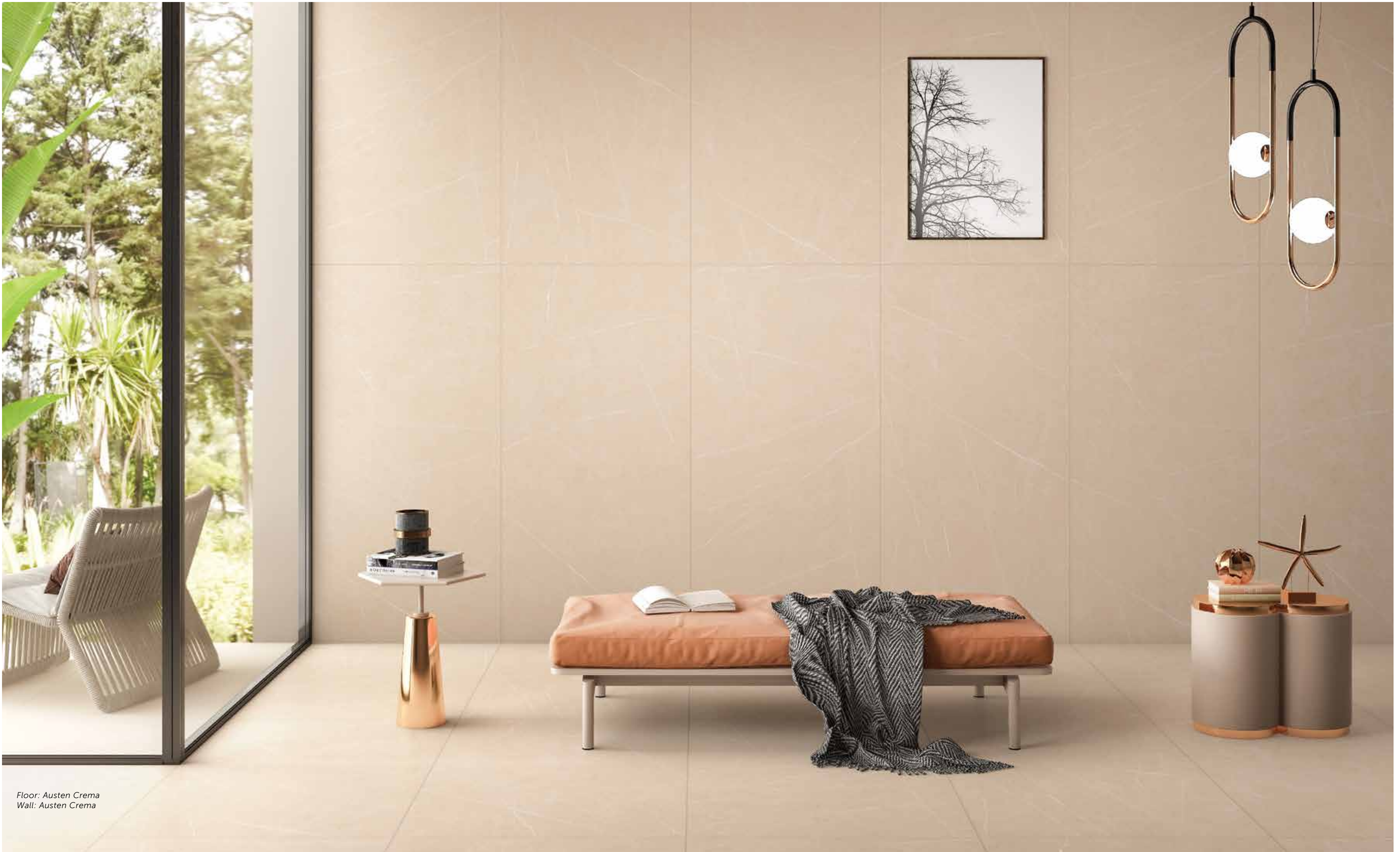

Floor: Austen Crema
Wall: Austen Crema



Floor: Austen Grey

MARBLE

AUSTEN CREMA

Vitrified tile
Polished | Carving | Baby Skin



>|< 9 mm
80x160 cm
31.49"x63"



austen crema

austen crema variations
80x160



| AUSTEN CREMA | SIZES (cm / inches) | THICKNESS (mm) |
|--------------|------------------------|-------------------|
| | 80x160 / 31.49 "x63" | 9 |

Note: For each slab, there will be multiple random faces with different graphic designs of the same genre. For best results of fixing slabs of any size / formats, across any application, please refer to the Maximus Technical Manual in this catalogue. Design images of the product are for illustrative purposes only and may differ in colour and design from the actual product. RAK Ceramics reserves the right to change the colour and the design of any product at its own discretion, without any prior notice.

MARBLE

AUSTEN GREY

Vitrified tile
Polished | Carving | Baby Skin



>|< 9 mm
80x160 cm
31.49"x63"



austen grey

austen grey variations
80x160

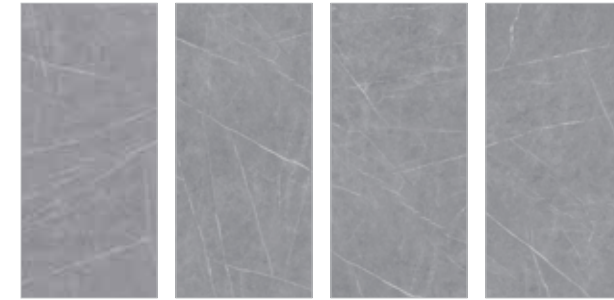

| AUSTEN GREY | SIZES (cm / inches) | THICKNESS (mm) |
|-------------|------------------------|-------------------|
| | 80x160 / 31.49 "x63" | 9 |

Note: For each slab, there will be multiple random faces with different graphic designs of the same genre. For best results of fixing slabs of any size / formats, across any application, please refer to the Maximus Technical Manual in this catalogue. Design images of the product are for illustrative purposes only and may differ in colour and design from the actual product. RAK Ceramics reserves the right to change the colour and the design of any product at its own discretion, without any prior notice.

MARBLE

BELITA BEIGE

9 mm
80x160 cm
 31.49"x63"

Vitrified tile
 Polished | Baby Skin



belita beige

belita beige variations
 80x160



| BELITA BEIGE | SIZES (cm / inches) | THICKNESS (mm) |
|--------------|------------------------|-------------------|
| | 80x160 / 31.49 "x63" | 9 |

Note: For each slab, there will be multiple random faces with different graphic designs of the same genre. For best results of fixing slabs of any size / formats, across any application, please refer to the Maximus Technical Manual in this catalogue. Design images of the product are for illustrative purposes only and may differ in colour and design from the actual product. RAK Ceramics reserves the right to change the colour and the design of any product at its own discretion, without any prior notice.



Floor: Belita Beige

MARBLE

BRONTE BRECCIA BEIGE

Vitrified tile
Polished | Baby Skin



9 mm
80x160 cm
31.49"x63"



bronte breccia beige

bronte breccia beige variations
80x160



| BRONTE BRECCIA BEIGE | SIZES (cm / inches) | THICKNESS (mm) |
|-------------------------|------------------------|-------------------|
| | 80x160 / 31.49 "x63" | 9 |

Note: For each slab, there will be multiple random faces with different graphic designs of the same genre. For best results of fixing slabs of any size / formats, across any application, please refer to the Maximus Technical Manual in this catalogue. Design images of the product are for illustrative purposes only and may differ in colour and design from the actual product. RAK Ceramics reserves the right to change the colour and the design of any product at its own discretion, without any prior notice.

MARBLE

BRONTE BRECCIA CREMA

Vitrified tile
Polished | Baby Skin



9 mm
80x160 cm
31.49"x63"



bronte breccia crema

bronte breccia crema variations
80x160



| BRONTE BRECCIA CREMA | SIZES (cm / inches) | THICKNESS (mm) |
|-------------------------|------------------------|-------------------|
| | 80x160 / 31.49 "x63" | 9 |

Note: For each slab, there will be multiple random faces with different graphic designs of the same genre. For best results of fixing slabs of any size / formats, across any application, please refer to the Maximus Technical Manual in this catalogue. Design images of the product are for illustrative purposes only and may differ in colour and design from the actual product. RAK Ceramics reserves the right to change the colour and the design of any product at its own discretion, without any prior notice.

MARBLE

COPPERFIELD BEIGE

Vitrified tile
Polished | Baby Skin



9 mm
80x160 cm
31.49"x63"



copperfield beige

copperfield beige variations
80x160

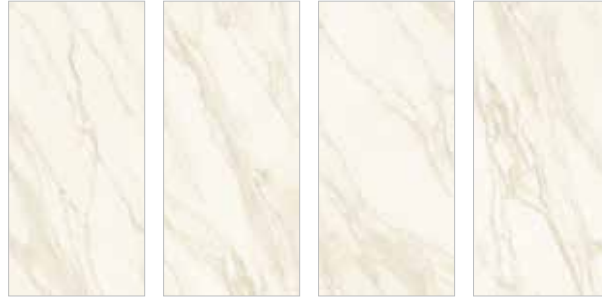

| COPPERFIELD BEIGE | SIZES (cm / inches) | THICKNESS (mm) |
|-------------------|------------------------|-------------------|
| | 80x160 / 31.49 "x63" | 9 |

Note: For each slab, there will be multiple random faces with different graphic designs of the same genre. For best results of fixing slabs of any size / formats, across any application, please refer to the Maximus Technical Manual in this catalogue. Design images of the product are for illustrative purposes only and may differ in colour and design from the actual product. RAK Ceramics reserves the right to change the colour and the design of any product at its own discretion, without any prior notice.



Floor: Copperfield Beige

MARBLE

CHARLES BIANCO

Vitrified tile
Polished



9 mm
80x160 cm
31.49"x63"



charles bianco

charles bianco variations
80x160



| CHARLES BIANCO | SIZES (cm / inches) | THICKNESS (mm) |
|----------------|------------------------|-------------------|
| | 80x160 / 31.49 "x63" | 9 |

Note: For each slab, there will be multiple random faces with different graphic designs of the same genre. For best results of fixing slabs of any size / formats, across any application, please refer to the Maximus Technical Manual in this catalogue. Design images of the product are for illustrative purposes only and may differ in colour and design from the actual product. RAK Ceramics reserves the right to change the colour and the design of any product at its own discretion, without any prior notice.

MARBLE

CRYSTAL GREY

Vitrified tile
Polished | Baby Skin



9 mm
80x160 cm
31.49"x63"



crystal grey

crystal grey variations
80x160

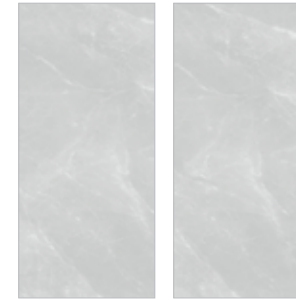

| CRYSTAL GREY | SIZES (cm / inches) | THICKNESS (mm) |
|--------------|------------------------|-------------------|
| | 80x160 / 31.49 "x63" | 9 |

Note: For each slab, there will be multiple random faces with different graphic designs of the same genre. For best results of fixing slabs of any size / formats, across any application, please refer to the Maximus Technical Manual in this catalogue. Design images of the product are for illustrative purposes only and may differ in colour and design from the actual product. RAK Ceramics reserves the right to change the colour and the design of any product at its own discretion, without any prior notice.

MARBLE

FORSTER GREY

9 mm
80x160 cm
31.49"x63"

Vitrified tile
Carving



forster grey

forster grey variations
80x160



| FORSTER GREY | SIZES (cm / inches) | THICKNESS (mm) |
|--------------|------------------------|-------------------|
| | 80x160 / 31.49 "x63" | 9 |

Note: For each slab, there will be multiple random faces with different graphic designs of the same genre. For best results of fixing slabs of any size / formats, across any application, please refer to the Maximus Technical Manual in this catalogue. Design images of the product are for illustrative purposes only and may differ in colour and design from the actual product. RAK Ceramics reserves the right to change the colour and the design of any product at its own discretion, without any prior notice.

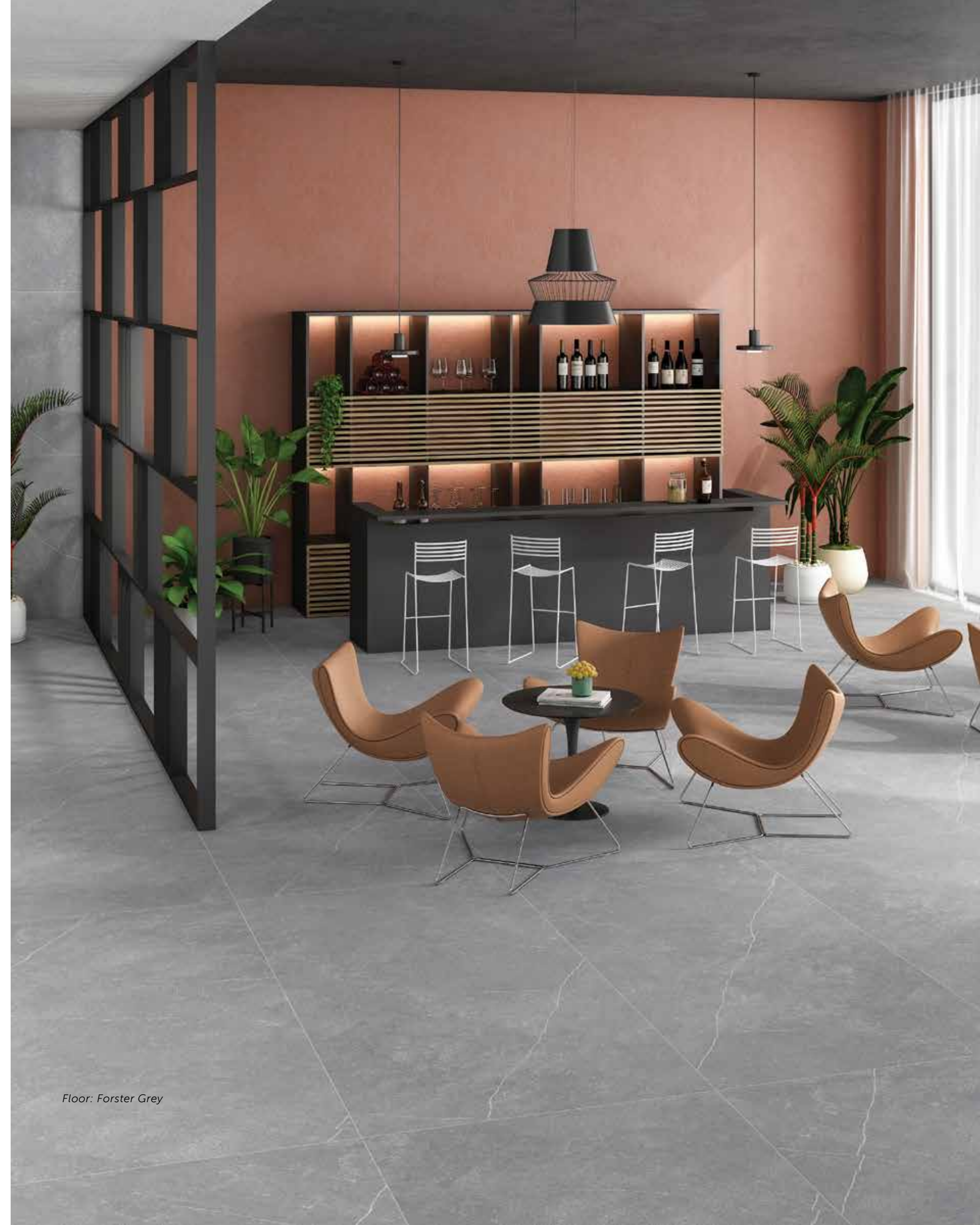

Floor: Forster Grey

MARBLE

FORSTER LIGHT GREY

Vitrified tile
Carving



>k 9 mm
80x160 cm
31.49"x63"

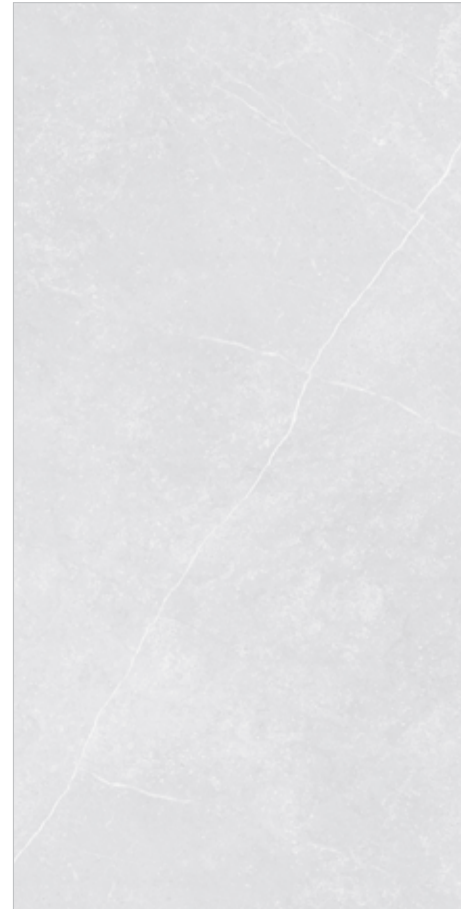

forster light grey

forster light grey variations
80x160



| FORSTER LIGHT GREY | SIZES (cm / inches) | THICKNESS (mm) |
|--------------------|------------------------|-------------------|
| | 80x160 / 31.49 "x63" | 9 |

Note: For each slab, there will be multiple random faces with different graphic designs of the same genre. For best results of fixing slabs of any size / formats, across any application, please refer to the Maximus Technical Manual in this catalogue. Design images of the product are for illustrative purposes only and may differ in colour and design from the actual product. RAK Ceramics reserves the right to change the colour and the design of any product at its own discretion, without any prior notice.

MARBLE

ORWELL GREY

Vitrified tile
Polished | Baby Skin



>k 9 mm
80x160 cm
31.49"x63"



orwell grey

orwell grey variations
80x160



| ORWELL GREY | SIZES (cm / inches) | THICKNESS (mm) |
|-------------|------------------------|-------------------|
| | 80x160 / 31.49 "x63" | 9 |

Note: For each slab, there will be multiple random faces with different graphic designs of the same genre. For best results of fixing slabs of any size / formats, across any application, please refer to the Maximus Technical Manual in this catalogue. Design images of the product are for illustrative purposes only and may differ in colour and design from the actual product. RAK Ceramics reserves the right to change the colour and the design of any product at its own discretion, without any prior notice.

MARBLE

OSCAR BEIGE

Vitrified tile
Polished



>k 9 mm
80x160 cm
31.49"x63"



oscar beige

oscar beige variations
80x160



| OSCAR BEIGE | SIZES (cm / inches) | THICKNESS (mm) |
|-------------|------------------------|-------------------|
| | 80x160 / 31.49 "x63" | 9 |

Note: For each slab, there will be multiple random faces with different graphic designs of the same genre. For best results of fixing slabs of any size / formats, across any application, please refer to the Maximus Technical Manual in this catalogue. Design images of the product are for illustrative purposes only and may differ in colour and design from the actual product. RAK Ceramics reserves the right to change the colour and the design of any product at its own discretion, without any prior notice.

MARBLE

OSCAR GREY

Vitrified tile
Polished



>k 9 mm
80x160 cm
31.49"x63"



oscar grey

oscar grey variations
80x160



| OSCAR GREY | SIZES (cm / inches) | THICKNESS (mm) |
|------------|------------------------|-------------------|
| | 80x160 / 31.49 "x63" | 9 |

Note: For each slab, there will be multiple random faces with different graphic designs of the same genre. For best results of fixing slabs of any size / formats, across any application, please refer to the Maximus Technical Manual in this catalogue. Design images of the product are for illustrative purposes only and may differ in colour and design from the actual product. RAK Ceramics reserves the right to change the colour and the design of any product at its own discretion, without any prior notice.

MARBLE

SYLVIA BRECCIA VERDE

Vitrified tile
Polished



>|< 9 mm
80x160 cm
31.49"x63"



sylvia breccia verde

sylvia breccia verde variations
80x160

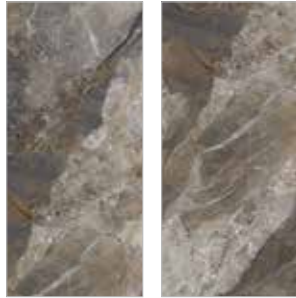

Floor: Sylvia Breccia Verde

| SYLVIA BRECCIA VERDE | SIZES (cm / inches) | THICKNESS (mm) |
|----------------------|------------------------|-------------------|
| | 80x160 / 31.49 "x63" | 9 |

Note: For each slab, there will be multiple random faces with different graphic designs of the same genre. For best results of fixing slabs of any size / formats, across any application, please refer to the Maximus Technical Manual in this catalogue. Design images of the product are for illustrative purposes only and may differ in colour and design from the actual product. RAK Ceramics reserves the right to change the colour and the design of any product at its own discretion, without any prior notice.

MARBLE

YEATS BRECCIA BEIGE

> 9 mm
80x160 cm
31.49"x63"

Vitrified tile
Polished



yeats breccia beige

yeats breccia beige variations
80x160



Floor: Yeats Breccia Beige

| YEATS BRECCIA BEIGE | SIZES (cm / inches) | THICKNESS (mm) |
|---------------------|------------------------|-------------------|
| | 80x160 / 31.49 "x63" | 9 |

Note: For each slab, there will be multiple random faces with different graphic designs of the same genre. For best results of fixing slabs of any size / formats, across any application, please refer to the Maximus Technical Manual in this catalogue. Design images of the product are for illustrative purposes only and may differ in colour and design from the actual product. RAK Ceramics reserves the right to change the colour and the design of any product at its own discretion, without any prior notice.

MARBLE

RUDYARD BEIGE

Vitrified tile
Polished



>|< 9 mm
80x160 cm
31.49"x63"



rudyard beige

rudyard beige variations
80x160



| RUDYARD BEIGE | SIZES (cm / inches) | THICKNESS (mm) |
|---------------|------------------------|-------------------|
| | 80x160 / 31.49 "x63" | 9 |

Note: For each slab, there will be multiple random faces with different graphic designs of the same genre. For best results of fixing slabs of any size / formats, across any application, please refer to the Maximus Technical Manual in this catalogue. Design images of the product are for illustrative purposes only and may differ in colour and design from the actual product. RAK Ceramics reserves the right to change the colour and the design of any product at its own discretion, without any prior notice.

MARBLE

ACADIA BEIGE

Vitrified tile
Polished



>|< 9 mm
80x160 cm
31.49"x63"



acadia beige

acadia beige variations
80x160



| ACADIA BEIGE | SIZES (cm / inches) | THICKNESS (mm) |
|--------------|------------------------|-------------------|
| | 80x160 / 31.49 "x63" | 9 |

Note: For each slab, there will be multiple random faces with different graphic designs of the same genre. For best results of fixing slabs of any size / formats, across any application, please refer to the Maximus Technical Manual in this catalogue. Design images of the product are for illustrative purposes only and may differ in colour and design from the actual product. RAK Ceramics reserves the right to change the colour and the design of any product at its own discretion, without any prior notice.

MARBLE

ANGELFISH BROWN

Vitrified tile
Polished



9 mm
80x160 cm
31.49"x63"



angelfish brown

angelfish brown variations
80x160



| ANGELFISH BROWN | SIZES (cm / inches) | THICKNESS (mm) |
|-----------------|------------------------|-------------------|
| | 80x160 / 31.49 "x63" | 9 |

Note: For each slab, there will be multiple random faces with different graphic designs of the same genre. For best results of fixing slabs of any size / formats, across any application, please refer to the Maximus Technical Manual in this catalogue. Design images of the product are for illustrative purposes only and may differ in colour and design from the actual product. RAK Ceramics reserves the right to change the colour and the design of any product at its own discretion, without any prior notice.

MARBLE

ANGELFISH CREMA

Vitrified tile
Polished



9 mm
80x160 cm
31.49"x63"



angelfish crema

angelfish crema variations
80x160



| ANGELFISH CREMA | SIZES (cm / inches) | THICKNESS (mm) |
|-----------------|------------------------|-------------------|
| | 80x160 / 31.49 "x63" | 9 |

Note: For each slab, there will be multiple random faces with different graphic designs of the same genre. For best results of fixing slabs of any size / formats, across any application, please refer to the Maximus Technical Manual in this catalogue. Design images of the product are for illustrative purposes only and may differ in colour and design from the actual product. RAK Ceramics reserves the right to change the colour and the design of any product at its own discretion, without any prior notice.

MARBLE

ANGELFISH GREY

Vitrified tile
Polished



>k 9 mm
80x160 cm
31.49"x63"



angelfish grey

angelfish grey variations
80x160

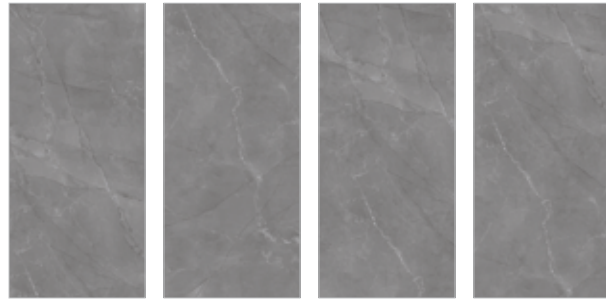

| ANGELFISH GREY | SIZES (cm / inches) | THICKNESS (mm) |
|----------------|------------------------|-------------------|
| | 80x160 / 31.49 "x63" | 9 |

MARBLE

ANGELFISH SILVER

Vitrified tile
Polished



>k 9 mm
80x160 cm
31.49"x63"



angelfish silver

angelfish silver variations
80x160

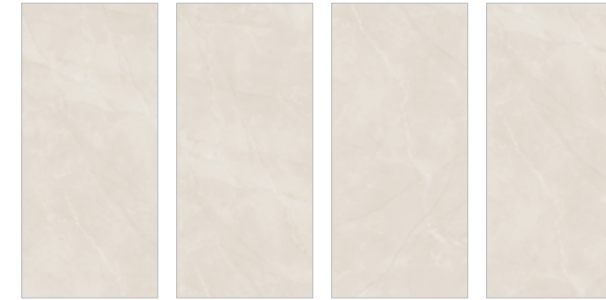

| ANGELFISH SILVER | SIZES (cm / inches) | THICKNESS (mm) |
|------------------|------------------------|-------------------|
| | 80x160 / 31.49 "x63" | 9 |

Note: For each slab, there will be multiple random faces with different graphic designs of the same genre. For best results of fixing slabs of any size / formats, across any application, please refer to the Maximus Technical Manual in this catalogue. Design images of the product are for illustrative purposes only and may differ in colour and design from the actual product. RAK Ceramics reserves the right to change the colour and the design of any product at its own discretion, without any prior notice.

Note: For each slab, there will be multiple random faces with different graphic designs of the same genre. For best results of fixing slabs of any size / formats, across any application, please refer to the Maximus Technical Manual in this catalogue. Design images of the product are for illustrative purposes only and may differ in colour and design from the actual product. RAK Ceramics reserves the right to change the colour and the design of any product at its own discretion, without any prior notice.

MARBLE

FLAMINGO BLUE

Vitrified tile
High Glossy



>k 9 mm
80x160 cm
31.49"x63"



flamingo blue

flamingo blue variations
80x160

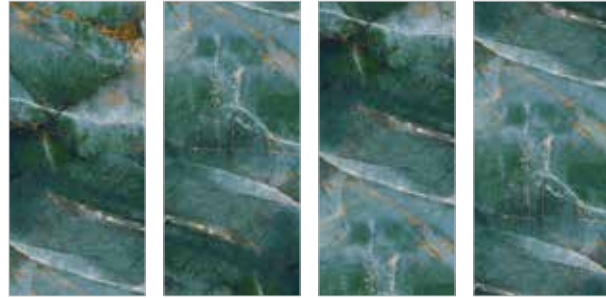

| FLAMINGO BLUE | SIZES (cm / inches) | THICKNESS (mm) |
|---------------|------------------------|-------------------|
| | 80x160 / 31.49 "x63" | 9 |

MARBLE

FLAMINGO BROWN

Vitrified tile
High Glossy



>k 9 mm
80x160 cm
31.49"x63"



flamingo brown

flamingo brown variations
80x160

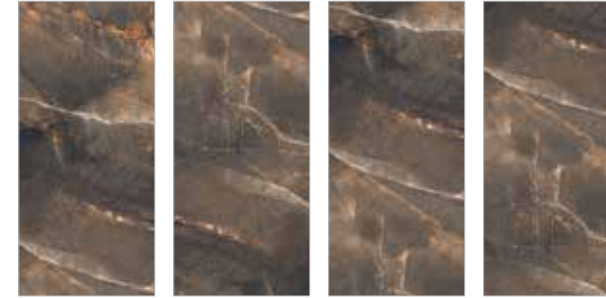

| FLAMINGO BROWN | SIZES (cm / inches) | THICKNESS (mm) |
|----------------|------------------------|-------------------|
| | 80x160 / 31.49 "x63" | 9 |

Note: For each slab, there will be multiple random faces with different graphic designs of the same genre. For best results of fixing slabs of any size / formats, across any application, please refer to the Maximus Technical Manual in this catalogue. Design images of the product are for illustrative purposes only and may differ in colour and design from the actual product. RAK Ceramics reserves the right to change the colour and the design of any product at its own discretion, without any prior notice.

Note: For each slab, there will be multiple random faces with different graphic designs of the same genre. For best results of fixing slabs of any size / formats, across any application, please refer to the Maximus Technical Manual in this catalogue. Design images of the product are for illustrative purposes only and may differ in colour and design from the actual product. RAK Ceramics reserves the right to change the colour and the design of any product at its own discretion, without any prior notice.

MARBLE

GRAND CANYON BEIGE

Vitrified tile
Polished



>k 9 mm
80x160 cm
31.49"x63"



grand canyon beige

grand canyon beige variations
80x160



| GRAND CANYON BEIGE | SIZES (cm / inches) | THICKNESS (mm) |
|-----------------------|------------------------|-------------------|
| | 80x160 / 31.49 "x63" | 9 |

MARBLE

GRAND CANYON BLACK

Vitrified tile
Polished



>k 9 mm
80x160 cm
31.49"x63"



grand canyon black

grand canyon black variations
80x160

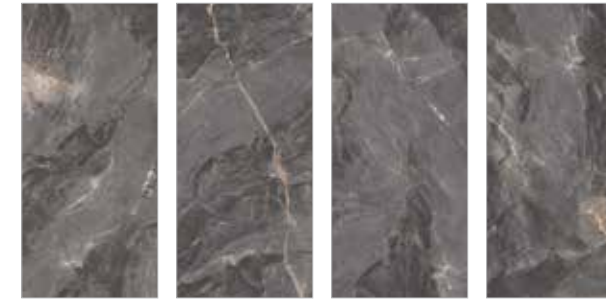

| GRAND CANYON BLACK | SIZES (cm / inches) | THICKNESS (mm) |
|-----------------------|------------------------|-------------------|
| | 80x160 / 31.49 "x63" | 9 |

Note: For each slab, there will be multiple random faces with different graphic designs of the same genre. For best results of fixing slabs of any size / formats, across any application, please refer to the Maximus Technical Manual in this catalogue. Design images of the product are for illustrative purposes only and may differ in colour and design from the actual product. RAK Ceramics reserves the right to change the colour and the design of any product at its own discretion, without any prior notice.

MARBLE

GRAND CANYON BROWN

Vitrified tile
Polished



>k 9 mm
80x160 cm
31.49"x63"



grand canyon brown

grand canyon brown variations
80x160



| GRAND CANYON BROWN | SIZES (cm / inches) | THICKNESS (mm) |
|--------------------|------------------------|-------------------|
| | 80x160 / 31.49 "x63" | 9 |

Note: For each slab, there will be multiple random faces with different graphic designs of the same genre. For best results of fixing slabs of any size / formats, across any application, please refer to the Maximus Technical Manual in this catalogue. Design images of the product are for illustrative purposes only and may differ in colour and design from the actual product. RAK Ceramics reserves the right to change the colour and the design of any product at its own discretion, without any prior notice.

MARBLE

GRAND CANYON WHITE

Vitrified tile
Polished



>k 9 mm
80x160 cm
31.49"x63"



grand canyon white

grand canyon white variations
80x160



| GRAND CANYON WHITE | SIZES (cm / inches) | THICKNESS (mm) |
|--------------------|------------------------|-------------------|
| | 80x160 / 31.49 "x63" | 9 |

Note: For each slab, there will be multiple random faces with different graphic designs of the same genre. For best results of fixing slabs of any size / formats, across any application, please refer to the Maximus Technical Manual in this catalogue. Design images of the product are for illustrative purposes only and may differ in colour and design from the actual product. RAK Ceramics reserves the right to change the colour and the design of any product at its own discretion, without any prior notice.

MARBLE

GULARIS BROWN

Vitrified tile
Polished



>k 9 mm
80x160 cm
31.49"x63"



gularis brown

gularis brown variations
80x160



| GULARIS BROWN | SIZES (cm / inches) | THICKNESS (mm) |
|---------------|------------------------|-------------------|
| | 80x160 / 31.49 "x63" | 9 |

Note: For each slab, there will be multiple random faces with different graphic designs of the same genre. For best results of fixing slabs of any size / formats, across any application, please refer to the Maximus Technical Manual in this catalogue. Design images of the product are for illustrative purposes only and may differ in colour and design from the actual product. RAK Ceramics reserves the right to change the colour and the design of any product at its own discretion, without any prior notice.

MARBLE

GULARIS GREY

Vitrified tile
Polished



>k 9 mm
80x160 cm
31.49"x63"



gularis grey

gularis grey variations
80x160

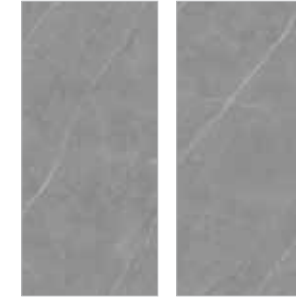

| GULARIS GREY | SIZES (cm / inches) | THICKNESS (mm) |
|--------------|------------------------|-------------------|
| | 80x160 / 31.49 "x63" | 9 |

Note: For each slab, there will be multiple random faces with different graphic designs of the same genre. For best results of fixing slabs of any size / formats, across any application, please refer to the Maximus Technical Manual in this catalogue. Design images of the product are for illustrative purposes only and may differ in colour and design from the actual product. RAK Ceramics reserves the right to change the colour and the design of any product at its own discretion, without any prior notice.

MARBLE

KEEL WHITE

Vitrified tile
Polished



>k 9 mm
80x160 cm
31.49"x63"



keel white

keel white variations
80x160



| KEEL WHITE | SIZES (cm / inches) | THICKNESS (mm) |
|------------|------------------------|-------------------|
| | 80x160 / 31.49 "x63" | 9 |

Note: For each slab, there will be multiple random faces with different graphic designs of the same genre. For best results of fixing slabs of any size / formats, across any application, please refer to the Maximus Technical Manual in this catalogue. Design images of the product are for illustrative purposes only and may differ in colour and design from the actual product. RAK Ceramics reserves the right to change the colour and the design of any product at its own discretion, without any prior notice.

MARBLE

MAGNOLIA BEIGE

Vitrified tile
Polished



>k 9 mm
80x160 cm
31.49"x63"



magnolia beige

magnolia beige variations
80x160

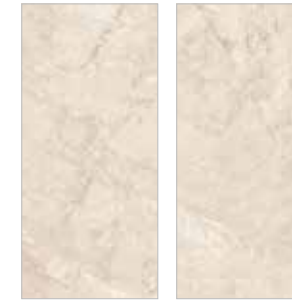

| MAGNOLIA BEIGE | SIZES (cm / inches) | THICKNESS (mm) |
|----------------|------------------------|-------------------|
| | 80x160 / 31.49 "x63" | 9 |

Note: For each slab, there will be multiple random faces with different graphic designs of the same genre. For best results of fixing slabs of any size / formats, across any application, please refer to the Maximus Technical Manual in this catalogue. Design images of the product are for illustrative purposes only and may differ in colour and design from the actual product. RAK Ceramics reserves the right to change the colour and the design of any product at its own discretion, without any prior notice.

MARBLE

PULPIS LIGHT BROWN

Vitrified tile
Polished



9 mm
80x160 cm
31.49"x63"



pulpis light brown

pulpis light brown variations
80x160



| PULPIS LIGHT BROWN | SIZES (cm / inches) | THICKNESS (mm) |
|--------------------|------------------------|-------------------|
| | 80x160 / 31.49 "x63" | 9 |

Note: For each slab, there will be multiple random faces with different graphic designs of the same genre. For best results of fixing slabs of any size / formats, across any application, please refer to the Maximus Technical Manual in this catalogue. Design images of the product are for illustrative purposes only and may differ in colour and design from the actual product. RAK Ceramics reserves the right to change the colour and the design of any product at its own discretion, without any prior notice.

MARBLE

MACAW BLUE

Vitrified tile
High Glossy



9 mm
80x160 cm
31.49"x63"

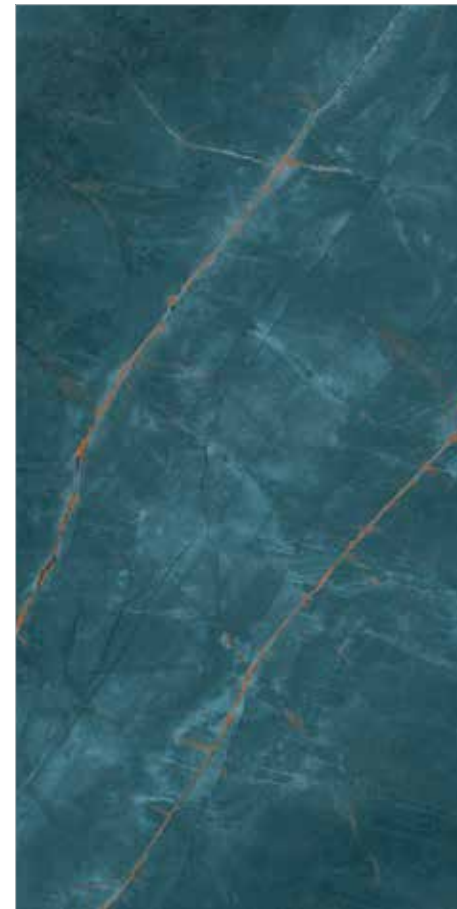

macaw blue

macaw blue variations
80x160

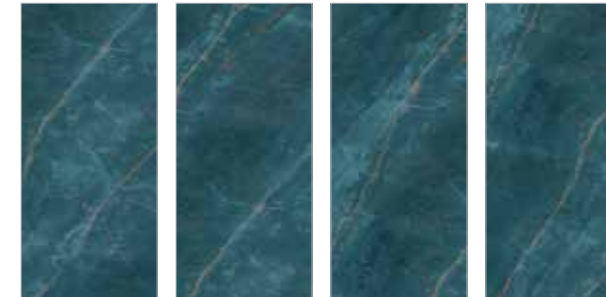

| MACAW BLUE | SIZES (cm / inches) | THICKNESS (mm) |
|------------|------------------------|-------------------|
| | 80x160 / 31.49 "x63" | 9 |

Note: For each slab, there will be multiple random faces with different graphic designs of the same genre. For best results of fixing slabs of any size / formats, across any application, please refer to the Maximus Technical Manual in this catalogue. Design images of the product are for illustrative purposes only and may differ in colour and design from the actual product. RAK Ceramics reserves the right to change the colour and the design of any product at its own discretion, without any prior notice.

MARBLE

LORIKEET BROWN

Vitrified tile
High Glossy



9 mm
80x160 cm
31.49"x63"



lorikeet brown

lorikeet brown variations
80x160

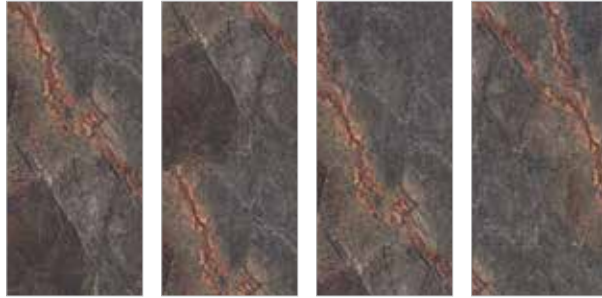

| LORIKEET BROWN | SIZES (cm / inches) | THICKNESS (mm) |
|----------------|------------------------|-------------------|
| | 80x160 / 31.49 "x63" | 9 |

Note: For each slab, there will be multiple random faces with different graphic designs of the same genre. For best results of fixing slabs of any size / formats, across any application, please refer to the Maximus Technical Manual in this catalogue. Design images of the product are for illustrative purposes only and may differ in colour and design from the actual product. RAK Ceramics reserves the right to change the colour and the design of any product at its own discretion, without any prior notice.

MARBLE

ORIOLE FOSSIL

Vitrified tile
High glossy



9 mm
80x160 cm
31.49"x63"



oriole fossil

oriole fossil variations
80x160



| ORIOLE FOSSIL | SIZES (cm / inches) | THICKNESS (mm) |
|---------------|------------------------|-------------------|
| | 80x160 / 31.49 "x63" | 9 |

Note: For each slab, there will be multiple random faces with different graphic designs of the same genre. For best results of fixing slabs of any size / formats, across any application, please refer to the Maximus Technical Manual in this catalogue. Design images of the product are for illustrative purposes only and may differ in colour and design from the actual product. RAK Ceramics reserves the right to change the colour and the design of any product at its own discretion, without any prior notice.

MARBLE

ORIOLE GREY

Vitrified tile
High glossy



> 9 mm
80x160 cm
31.49"x63"



oriole grey

oriole grey variations
80x160



| ORIOLE GREY | SIZES (cm / inches) | THICKNESS (mm) |
|-------------|------------------------|-------------------|
| | 80x160 / 31.49 "x63" | 9 |

Note: For each slab, there will be multiple random faces with different graphic designs of the same genre. For best results of fixing slabs of any size / formats, across any application, please refer to the Maximus Technical Manual in this catalogue. Design images of the product are for illustrative purposes only and may differ in colour and design from the actual product. RAK Ceramics reserves the right to change the colour and the design of any product at its own discretion, without any prior notice.

MARBLE

ORIOLE WHITE

Vitrified tile
High glossy



> 9 mm
80x160 cm
31.49"x63"



oriole white

oriole white variations
80x160

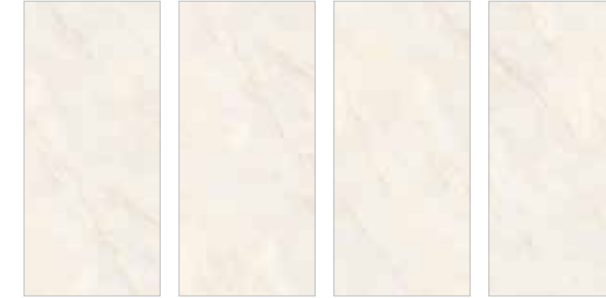

| ORIOLE WHITE | SIZES (cm / inches) | THICKNESS (mm) |
|--------------|------------------------|-------------------|
| | 80x160 / 31.49 "x63" | 9 |

Note: For each slab, there will be multiple random faces with different graphic designs of the same genre. For best results of fixing slabs of any size / formats, across any application, please refer to the Maximus Technical Manual in this catalogue. Design images of the product are for illustrative purposes only and may differ in colour and design from the actual product. RAK Ceramics reserves the right to change the colour and the design of any product at its own discretion, without any prior notice.

MARBLE

PASSERINA VERDE

Vitrified tile
Carving



> 9 mm
80x160 cm
31.49"x63"



passerina verde

passerina verde variations
80x160



| PASSERINA VERDE | SIZES (cm / inches) | THICKNESS (mm) |
|-----------------|------------------------|-------------------|
| | 80x160 / 31.49 "x63" | 9 |

Note: For each slab, there will be multiple random faces with different graphic designs of the same genre. For best results of fixing slabs of any size / formats, across any application, please refer to the Maximus Technical Manual in this catalogue. Design images of the product are for illustrative purposes only and may differ in colour and design from the actual product. RAK Ceramics reserves the right to change the colour and the design of any product at its own discretion, without any prior notice.

MARBLE

PASSERINA BEIGE

Vitrified tile
Carving



> 9 mm
80x160 cm
31.49"x63"

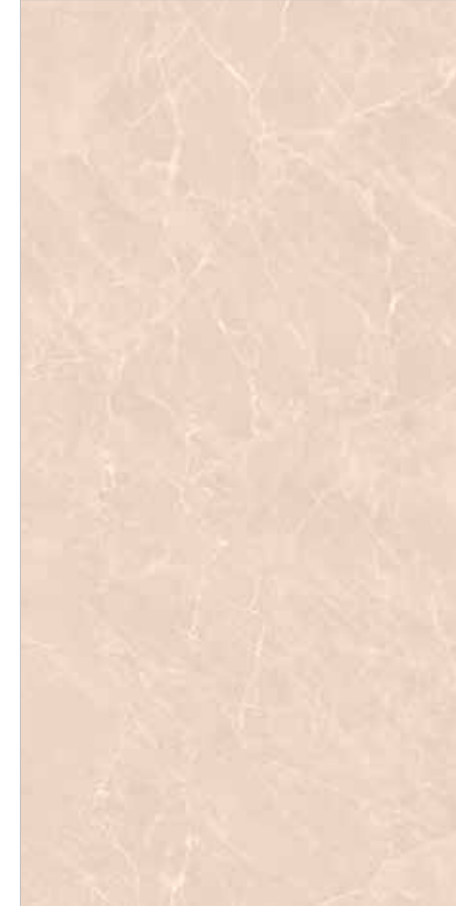

passerina beige

passerina beige variations
80x160



| PASSERINA BEIGE | SIZES (cm / inches) | THICKNESS (mm) |
|-----------------|------------------------|-------------------|
| | 80x160 / 31.49 "x63" | 9 |

Note: For each slab, there will be multiple random faces with different graphic designs of the same genre. For best results of fixing slabs of any size / formats, across any application, please refer to the Maximus Technical Manual in this catalogue. Design images of the product are for illustrative purposes only and may differ in colour and design from the actual product. RAK Ceramics reserves the right to change the colour and the design of any product at its own discretion, without any prior notice.

MARBLE

PUFFIN GREY

Vitrified tile
High Glossy



> 9 mm
80x160 cm
31.49"x63"



puffin grey

puffin grey variations
80x160



| PUFFIN GREY | SIZES (cm / inches) | THICKNESS (mm) |
|-------------|------------------------|-------------------|
| | 80x160 / 31.49 "x63" | 9 |

Note: For each slab, there will be multiple random faces with different graphic designs of the same genre. For best results of fixing slabs of any size / formats, across any application, please refer to the Maximus Technical Manual in this catalogue. Design images of the product are for illustrative purposes only and may differ in colour and design from the actual product. RAK Ceramics reserves the right to change the colour and the design of any product at its own discretion, without any prior notice.

MARBLE

TURACOS LIGHT GREY

Vitrified tile
Carving



> 9 mm
80x160 cm
31.49"x63"

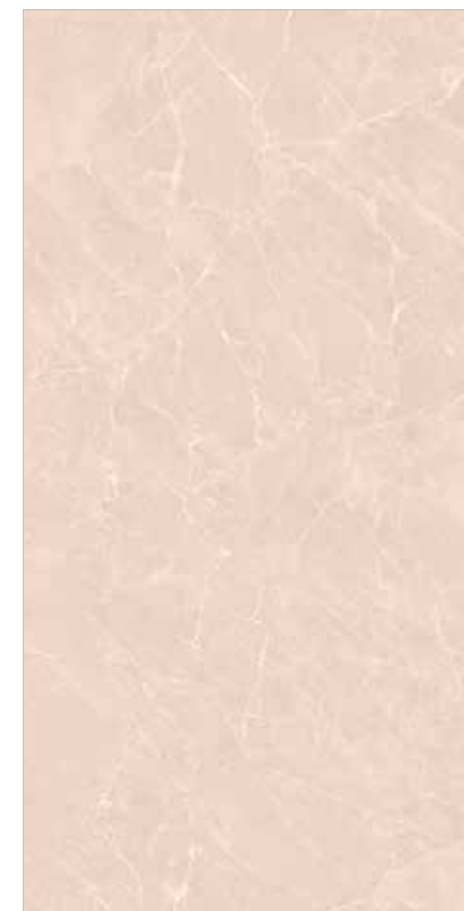

turacos light grey

turacos light grey variations
80x160

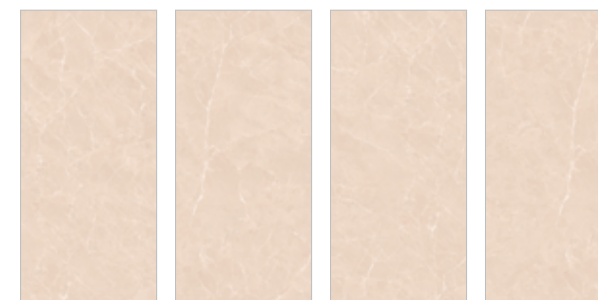

| TURACOS LIGHT GREY | SIZES (cm / inches) | THICKNESS (mm) |
|--------------------|------------------------|-------------------|
| | 80x160 / 31.49 "x63" | 9 |

Note: For each slab, there will be multiple random faces with different graphic designs of the same genre. For best results of fixing slabs of any size / formats, across any application, please refer to the Maximus Technical Manual in this catalogue. Design images of the product are for illustrative purposes only and may differ in colour and design from the actual product. RAK Ceramics reserves the right to change the colour and the design of any product at its own discretion, without any prior notice.



Floor: Lasa Bianco



Floor: Michigan Beige



Floor: Georgia Grey



Floor: Hemrock Grey



Floor: Minnesota Black
Wall: minnesota black & Barley



Floor: Carolina Grey

MARBLE

OYSTER MARFIL

Vitrified tile
Polished



9 mm
120x180 cm
47.24"x70.86"



oyster marfil

oyster marfil variations
120x180



| OYSTER MARFIL | SIZES (cm / inches) | THICKNESS (mm) |
|---------------|-------------------------|-------------------|
| | 120x180 / 47.24"x70.86" | 9 |

Note: For each slab, there will be multiple random faces with different graphic designs of the same genre. For best results of fixing slabs of any size / formats, across any application, please refer to the Maximus Technical Manual in this catalogue. Design images of the product are for illustrative purposes only and may differ in colour and design from the actual product. RAK Ceramics reserves the right to change the colour and the design of any product at its own discretion, without any prior notice.

MARBLE

ALPS BEIGE

Vitrified tile
Polished



9 mm
120x180 cm
47.24"x70.86"



alps beige

alps beige variations
120x180



| ALPS BEIGE | SIZES (cm / inches) | THICKNESS (mm) |
|------------|-------------------------|-------------------|
| | 120x180 / 47.24"x70.86" | 9 |

Note: For each slab, there will be multiple random faces with different graphic designs of the same genre. For best results of fixing slabs of any size / formats, across any application, please refer to the Maximus Technical Manual in this catalogue. Design images of the product are for illustrative purposes only and may differ in colour and design from the actual product. RAK Ceramics reserves the right to change the colour and the design of any product at its own discretion, without any prior notice.

MARBLE

ARIA BIANCO

Vitrified tile
Polished



9 mm
120x180 cm
47.24"x70.86"



aria bianco variations
120x180



aria bianco

| ARIA BIANCO | SIZES (cm / inches) | THICKNESS (mm) |
|-------------|-------------------------|-------------------|
| | 120x180 / 47.24"x70.86" | 9 |

Note: For each slab, there will be multiple random faces with different graphic designs of the same genre. For best results of fixing slabs of any size / formats, across any application, please refer to the Maximus Technical Manual in this catalogue. Design images of the product are for illustrative purposes only and may differ in colour and design from the actual product. RAK Ceramics reserves the right to change the colour and the design of any product at its own discretion, without any prior notice.

MARBLE

ARMANI GRIGIO

Vitrified tile
Polished



9 mm
120x180 cm
47.24"x70.86"



armani grigio variations
120x180



armani grigio

| ARMANI GRIGIO | SIZES (cm / inches) | THICKNESS (mm) |
|---------------|-------------------------|-------------------|
| | 120x180 / 47.24"x70.86" | 9 |

Note: For each slab, there will be multiple random faces with different graphic designs of the same genre. For best results of fixing slabs of any size / formats, across any application, please refer to the Maximus Technical Manual in this catalogue. Design images of the product are for illustrative purposes only and may differ in colour and design from the actual product. RAK Ceramics reserves the right to change the colour and the design of any product at its own discretion, without any prior notice.

MARBLE

BOTTOCHINO SUPREME

Vitrified tile
Polished



9 mm
120x180 cm
47.24"x70.86"



bottochino supreme variations
120x180



bottochino supreme

| BOTTOCHINO SUPREME | SIZES (cm / inches) | THICKNESS (mm) |
|--------------------|-------------------------|----------------|
| | 120x180 / 47.24"x70.86" | 9 |

Note: For each slab, there will be multiple random faces with different graphic designs of the same genre. For best results of fixing slabs of any size / formats, across any application, please refer to the Maximus Technical Manual in this catalogue. Design images of the product are for illustrative purposes only and may differ in colour and design from the actual product. RAK Ceramics reserves the right to change the colour and the design of any product at its own discretion, without any prior notice.

MARBLE

DYNA REGAL BEIGE

Vitrified tile
Polished



9 mm
120x180 cm
47.24"x70.86"



dyna regal beige variations
120x180

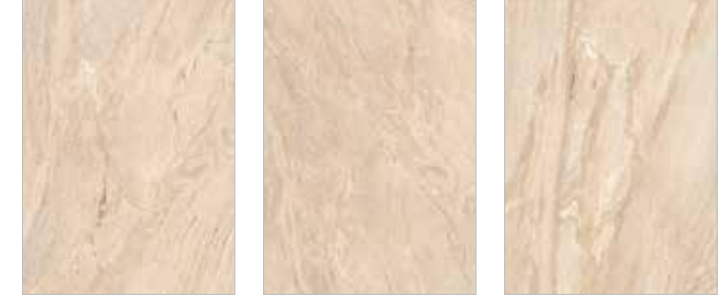

dyna regal beige

| DYNA REGAL BEIGE | SIZES (cm / inches) | THICKNESS (mm) |
|------------------|-------------------------|----------------|
| | 120x180 / 47.24"x70.86" | 9 |

Note: For each slab, there will be multiple random faces with different graphic designs of the same genre. For best results of fixing slabs of any size / formats, across any application, please refer to the Maximus Technical Manual in this catalogue. Design images of the product are for illustrative purposes only and may differ in colour and design from the actual product. RAK Ceramics reserves the right to change the colour and the design of any product at its own discretion, without any prior notice.

MARBLE

BRECCIA NATURAL

Vitrified tile
Polished



> 9 mm
120x180 cm
47.24"x70.86"



breccia natural variations
120x180



breccia natural

| BRECCIA NATURAL | SIZES (cm / inches) | THICKNESS (mm) |
|-----------------|-------------------------|-------------------|
| | 120x180 / 47.24"x70.86" | 9 |

Note: For each slab, there will be multiple random faces with different graphic designs of the same genre. For best results of fixing slabs of any size / formats, across any application, please refer to the Maximus Technical Manual in this catalogue. Design images of the product are for illustrative purposes only and may differ in colour and design from the actual product. RAK Ceramics reserves the right to change the colour and the design of any product at its own discretion, without any prior notice.



Floor: Breccia Natural

MARBLE

COSMOS CREMA

Vitrified tile
Polished



>|< 9 mm
120x180 cm
47.24"x70.86"



cosmos crema variations
120x180



cosmos crema

| COSMOS CREMA | SIZES (cm / inches) | THICKNESS (mm) |
|--------------|-------------------------|-------------------|
| | 120x180 / 47.24"x70.86" | 9 |

Note: For each slab, there will be multiple random faces with different graphic designs of the same genre. For best results of fixing slabs of any size / formats, across any application, please refer to the Maximus Technical Manual in this catalogue. Design images of the product are for illustrative purposes only and may differ in colour and design from the actual product. RAK Ceramics reserves the right to change the colour and the design of any product at its own discretion, without any prior notice.

MARBLE

GRACIOUS BEIGE

Vitrified tile
Polished



>|< 9 mm
120x180 cm
47.24"x70.86"



gracious beige variations
120x180



gracious beige

| GRACIOUS BEIGE | SIZES (cm / inches) | THICKNESS (mm) |
|----------------|-------------------------|-------------------|
| | 120x180 / 47.24"x70.86" | 9 |

Note: For each slab, there will be multiple random faces with different graphic designs of the same genre. For best results of fixing slabs of any size / formats, across any application, please refer to the Maximus Technical Manual in this catalogue. Design images of the product are for illustrative purposes only and may differ in colour and design from the actual product. RAK Ceramics reserves the right to change the colour and the design of any product at its own discretion, without any prior notice.

MARBLE

HARBOUR GREY

Vitrified tile
Polished



>|< 9 mm
120x180 cm
47.24"x70.86"



harbour grey

harbour grey variations
120x180



| HARBOUR GREY | SIZES (cm / inches) | THICKNESS (mm) |
|--------------|-------------------------|-------------------|
| | 120x180 / 47.24"x70.86" | 9 |

Note: For each slab, there will be multiple random faces with different graphic designs of the same genre. For best results of fixing slabs of any size / formats, across any application, please refer to the Maximus Technical Manual in this catalogue. Design images of the product are for illustrative purposes only and may differ in colour and design from the actual product. RAK Ceramics reserves the right to change the colour and the design of any product at its own discretion, without any prior notice.



Floor: Harbour Grey

MARBLE

HONEY STRIATO ONYX

Vitrified tile
Polished



9 mm
120x180 cm
47.24"x70.86"



honey striato onyx

| HONEY STRIATO ONYX | SIZES (cm / inches) | THICKNESS (mm) |
|--------------------|-------------------------|-------------------|
| | 120x180 / 47.24"x70.86" | 9 |

Note: For each slab, there will be multiple random faces with different graphic designs of the same genre. For best results of fixing slabs of any size / formats, across any application, please refer to the Maximus Technical Manual in this catalogue. Design images of the product are for illustrative purposes only and may differ in colour and design from the actual product. RAK Ceramics reserves the right to change the colour and the design of any product at its own discretion, without any prior notice.

MARBLE

LEXUS BROWN

Vitrified tile
Polished



9 mm
120x180 cm
47.24"x70.86"



lexus brown

lexus brown variations
120x180



| LEXUS BROWN | SIZES (cm / inches) | THICKNESS (mm) |
|-------------|-------------------------|-------------------|
| | 120x180 / 47.24"x70.86" | 9 |

Note: For each slab, there will be multiple random faces with different graphic designs of the same genre. For best results of fixing slabs of any size / formats, across any application, please refer to the Maximus Technical Manual in this catalogue. Design images of the product are for illustrative purposes only and may differ in colour and design from the actual product. RAK Ceramics reserves the right to change the colour and the design of any product at its own discretion, without any prior notice.

MARBLE

MARFIL MAJESTIC

Vitrified tile
Polished



9 mm
120x180 cm
47.24"x70.86"



marfil majestic variations
120x180



marfil majestic

| MARFIL MAJESTIC | SIZES (cm / inches) | THICKNESS (mm) |
|-----------------|-------------------------|-------------------|
| | 120x180 / 47.24"x70.86" | 9 |

Note: For each slab, there will be multiple random faces with different graphic designs of the same genre. For best results of fixing slabs of any size / formats, across any application, please refer to the Maximus Technical Manual in this catalogue. Design images of the product are for illustrative purposes only and may differ in colour and design from the actual product. RAK Ceramics reserves the right to change the colour and the design of any product at its own discretion, without any prior notice.

MARBLE

NEW SCREPLATO LBR

Vitrified tile
Polished



9 mm
120x180 cm
47.24"x70.86"



new screplato lbr variations
120x180



new screplato lbr

| NEW SCREPLATO LBR | SIZES (cm / inches) | THICKNESS (mm) |
|-------------------|-------------------------|-------------------|
| | 120x180 / 47.24"x70.86" | 9 |

Note: For each slab, there will be multiple random faces with different graphic designs of the same genre. For best results of fixing slabs of any size / formats, across any application, please refer to the Maximus Technical Manual in this catalogue. Design images of the product are for illustrative purposes only and may differ in colour and design from the actual product. RAK Ceramics reserves the right to change the colour and the design of any product at its own discretion, without any prior notice.

MARBLE

NEW SCREPLATO NIGHT

Vitrified tile
Polished



9 mm
120x180 cm
47.24"x70.86"

new screplato night variations
120x180



new screplato night

| NEW SCREPLATO NIGHT | SIZES (cm / inches) | THICKNESS (mm) |
|---------------------|-------------------------|-------------------|
| | 120x180 / 47.24"x70.86" | 9 |

Note: For each slab, there will be multiple random faces with different graphic designs of the same genre. For best results of fixing slabs of any size / formats, across any application, please refer to the Maximus Technical Manual in this catalogue. Design images of the product are for illustrative purposes only and may differ in colour and design from the actual product. RAK Ceramics reserves the right to change the colour and the design of any product at its own discretion, without any prior notice.



Floor: New Screplato Night

MARBLE

ONYX URBAN

Vitrified tile
Polished



>|< 9 mm
120x180 cm
47.24"x70.86"



onyx urban

onyx urban variations
120x180



| ONYX URBAN | SIZES (cm / inches) | THICKNESS (mm) |
|------------|-------------------------|-------------------|
| | 120x180 / 47.24"x70.86" | 9 |

Note: For each slab, there will be multiple random faces with different graphic designs of the same genre. For best results of fixing slabs of any size / formats, across any application, please refer to the Maximus Technical Manual in this catalogue. Design images of the product are for illustrative purposes only and may differ in colour and design from the actual product. RAK Ceramics reserves the right to change the colour and the design of any product at its own discretion, without any prior notice.

MARBLE

PLATINUM GREY

Vitrified tile
Polished



>|< 9 mm
120x180 cm
47.24"x70.86"



platinum grey

platinum grey variations
120x180

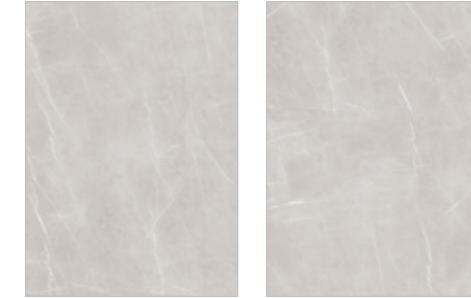

| PLATINUM GREY | SIZES (cm / inches) | THICKNESS (mm) |
|---------------|-------------------------|-------------------|
| | 120x180 / 47.24"x70.86" | 9 |

Note: For each slab, there will be multiple random faces with different graphic designs of the same genre. For best results of fixing slabs of any size / formats, across any application, please refer to the Maximus Technical Manual in this catalogue. Design images of the product are for illustrative purposes only and may differ in colour and design from the actual product. RAK Ceramics reserves the right to change the colour and the design of any product at its own discretion, without any prior notice.

MARBLE

STATUARIO LARGE

Vitrified tile
Polished



>|< 9 mm
120x180 cm
47.24"x70.86"



statuario large

statuario large variations
120x180

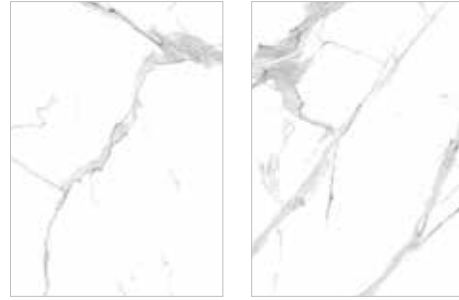

| STATUARIO LARGE | SIZES (cm / inches) | THICKNESS (mm) |
|-----------------|-------------------------|-------------------|
| | 120x180 / 47.24"x70.86" | 9 |

Note: For each slab, there will be multiple random faces with different graphic designs of the same genre. For best results of fixing slabs of any size / formats, across any application, please refer to the Maximus Technical Manual in this catalogue. Design images of the product are for illustrative purposes only and may differ in colour and design from the actual product. RAK Ceramics reserves the right to change the colour and the design of any product at its own discretion, without any prior notice.

MARBLE

THALES GREY

Vitrified tile
Polished



>|< 9 mm
120x180 cm
47.24"x70.86"



thales grey

thales grey variations
120x180

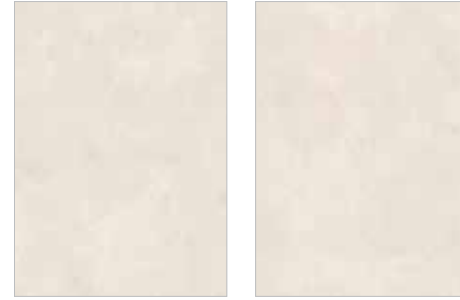

| THALES GREY | SIZES (cm / inches) | THICKNESS (mm) |
|-------------|-------------------------|-------------------|
| | 120x180 / 47.24"x70.86" | 9 |

Note: For each slab, there will be multiple random faces with different graphic designs of the same genre. For best results of fixing slabs of any size / formats, across any application, please refer to the Maximus Technical Manual in this catalogue. Design images of the product are for illustrative purposes only and may differ in colour and design from the actual product. RAK Ceramics reserves the right to change the colour and the design of any product at its own discretion, without any prior notice.

MARBLE

THALES BEIGE

Vitrified tile
Polished



> 9 mm
120x180 cm
47.24"x70.86"



thales beige

thales beige variations
120x180



| THALES BEIGE | SIZES (cm / inches) | THICKNESS (mm) |
|--------------|-------------------------|-------------------|
| | 120x180 / 47.24"x70.86" | 9 |

Note: For each slab, there will be multiple random faces with different graphic designs of the same genre. For best results of fixing slabs of any size / formats, across any application, please refer to the Maximus Technical Manual in this catalogue. Design images of the product are for illustrative purposes only and may differ in colour and design from the actual product. RAK Ceramics reserves the right to change the colour and the design of any product at its own discretion, without any prior notice.



Floor: Thales Beige

MARBLE

STATUARIO SVARNAM

Vitrified tile
Polished



>|< 9 mm
120x180 cm
47.24"x70.86"



statuario svarnam

statuario svarnam variations
120x180

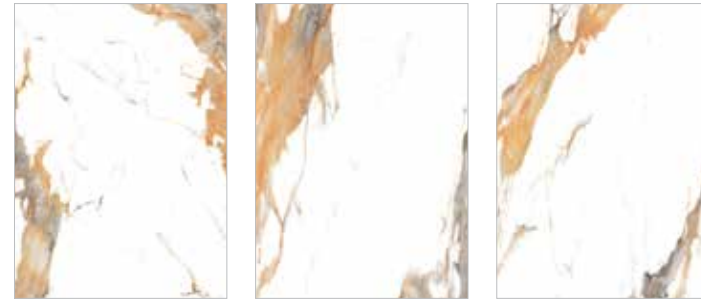

| STATUARIO SVARNAM | SIZES (cm / inches) | THICKNESS (mm) |
|-------------------|-------------------------|-------------------|
| | 120x180 / 47.24"x70.86" | 9 |

Note: For each slab, there will be multiple random faces with different graphic designs of the same genre. For best results of fixing slabs of any size / formats, across any application, please refer to the Maximus Technical Manual in this catalogue. Design images of the product are for illustrative purposes only and may differ in colour and design from the actual product. RAK Ceramics reserves the right to change the colour and the design of any product at its own discretion, without any prior notice.

MARBLE

TOURMALINE GREY

Vitrified tile
Polished



>|< 9 mm
120x180 cm
47.24"x70.86"



tourmaline grey

tourmaline grey variations
120x180



| TOURMALINE GREY | SIZES (cm / inches) | THICKNESS (mm) |
|-----------------|-------------------------|-------------------|
| | 120x180 / 47.24"x70.86" | 9 |

Note: For each slab, there will be multiple random faces with different graphic designs of the same genre. For best results of fixing slabs of any size / formats, across any application, please refer to the Maximus Technical Manual in this catalogue. Design images of the product are for illustrative purposes only and may differ in colour and design from the actual product. RAK Ceramics reserves the right to change the colour and the design of any product at its own discretion, without any prior notice.

MARBLE

VERASACE ORO

Vitrified tile
Polished



9 mm
120x180 cm
47.24"x70.86"



verasace oro

verasace oro variations
120x180



| VERASACE ORO | SIZES (cm / inches) | THICKNESS (mm) |
|--------------|-------------------------|-------------------|
| | 120x180 / 47.24"x70.86" | 9 |

Note: For each slab, there will be multiple random faces with different graphic designs of the same genre. For best results of fixing slabs of any size / formats, across any application, please refer to the Maximus Technical Manual in this catalogue. Design images of the product are for illustrative purposes only and may differ in colour and design from the actual product. RAK Ceramics reserves the right to change the colour and the design of any product at its own discretion, without any prior notice.



Floor: Verasace Oro

MARBLE

WONDER GREY

Vitrified tile
Polished



>|< 9 mm
120x180 cm
47.24"x70.86"



wonder grey

wonder grey variations
120x180



| WONDER GREY | SIZES (cm / inches) | THICKNESS (mm) |
|-------------|-------------------------|-------------------|
| | 120x180 / 47.24"x70.86" | 9 |

Note: For each slab, there will be multiple random faces with different graphic designs of the same genre. For best results of fixing slabs of any size / formats, across any application, please refer to the Maximus Technical Manual in this catalogue. Design images of the product are for illustrative purposes only and may differ in colour and design from the actual product. RAK Ceramics reserves the right to change the colour and the design of any product at its own discretion, without any prior notice.

MARBLE

KANSAS IVORY

Vitrified tile
Polished



>|< 9 mm
120x180 cm
47.24"x70.86"



kansas ivory

kansas ivory variations
120x180

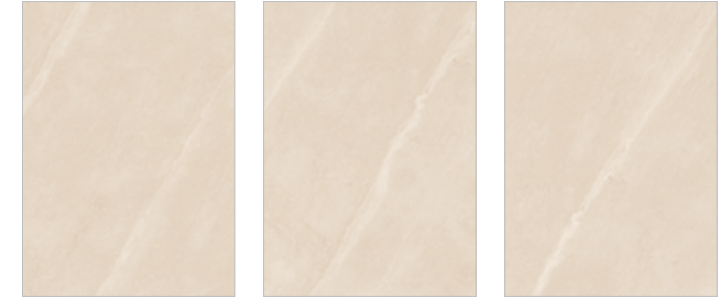

| KANSAS IVORY | SIZES (cm / inches) | THICKNESS (mm) |
|--------------|-------------------------|-------------------|
| | 120x180 / 47.24"x70.86" | 9 |

Note: For each slab, there will be multiple random faces with different graphic designs of the same genre. For best results of fixing slabs of any size / formats, across any application, please refer to the Maximus Technical Manual in this catalogue. Design images of the product are for illustrative purposes only and may differ in colour and design from the actual product. RAK Ceramics reserves the right to change the colour and the design of any product at its own discretion, without any prior notice.

MARBLE

BRUGES WHITE

Vitrified tile
Polished



>|< 9 mm
120x180 cm
47.24"x70.86"



bruges white

bruges white variations
120x180



| BRUGES WHITE | SIZES (cm / inches) | THICKNESS (mm) |
|--------------|-------------------------|-------------------|
| | 120x180 / 47.24"x70.86" | 9 |

MARBLE

PROCIDA BEIGE

Vitrified tile
Polished



>|< 9 mm
120x180 cm
47.24"x70.86"



procida beige

procida beige variations
120x180



| PROCIDA BEIGE | SIZES (cm / inches) | THICKNESS (mm) |
|---------------|-------------------------|-------------------|
| | 120x180 / 47.24"x70.86" | 9 |

Note: For each slab, there will be multiple random faces with different graphic designs of the same genre. For best results of fixing slabs of any size / formats, across any application, please refer to the Maximus Technical Manual in this catalogue. Design images of the product are for illustrative purposes only and may differ in colour and design from the actual product. RAK Ceramics reserves the right to change the colour and the design of any product at its own discretion, without any prior notice.

Note: For each slab, there will be multiple random faces with different graphic designs of the same genre. For best results of fixing slabs of any size / formats, across any application, please refer to the Maximus Technical Manual in this catalogue. Design images of the product are for illustrative purposes only and may differ in colour and design from the actual product. RAK Ceramics reserves the right to change the colour and the design of any product at its own discretion, without any prior notice.

MARBLE

CARARA WHITE

Vitrified tile
Polished



>|< 9 mm
120x180 cm
47.24"x70.86"



carara white

carara white variations
120x180



| CARARA WHITE | SIZES (cm / inches) | THICKNESS (mm) |
|--------------|-------------------------|-------------------|
| | 120x180 / 47.24"x70.86" | 9 |

Note: For each slab, there will be multiple random faces with different graphic designs of the same genre. For best results of fixing slabs of any size / formats, across any application, please refer to the Maximus Technical Manual in this catalogue. Design images of the product are for illustrative purposes only and may differ in colour and design from the actual product. RAK Ceramics reserves the right to change the colour and the design of any product at its own discretion, without any prior notice.

MARBLE

PERLATO SICILY

Vitrified tile
Polished



>|< 9 mm
120x180 cm
47.24"x70.86"



perlato sicily

perlato sicily variations
120x180



| PERLATO SICILY | SIZES (cm / inches) | THICKNESS (mm) |
|----------------|-------------------------|-------------------|
| | 120x180 / 47.24"x70.86" | 9 |

Note: For each slab, there will be multiple random faces with different graphic designs of the same genre. For best results of fixing slabs of any size / formats, across any application, please refer to the Maximus Technical Manual in this catalogue. Design images of the product are for illustrative purposes only and may differ in colour and design from the actual product. RAK Ceramics reserves the right to change the colour and the design of any product at its own discretion, without any prior notice.

MARBLE

PALERMO WHITE

Vitrified tile
Polished



>|< 9 mm
120x180 cm
47.24"x70.86"



palermo white

palermo white variations
120x180



| PALERMO WHITE | SIZES (cm / inches) | THICKNESS (mm) |
|---------------|-------------------------|-------------------|
| | 120x180 / 47.24"x70.86" | 9 |

Note: For each slab, there will be multiple random faces with different graphic designs of the same genre. For best results of fixing slabs of any size / formats, across any application, please refer to the Maximus Technical Manual in this catalogue. Design images of the product are for illustrative purposes only and may differ in colour and design from the actual product. RAK Ceramics reserves the right to change the colour and the design of any product at its own discretion, without any prior notice.

MARBLE

CARDINAL CLASSIC

Vitrified tile
High Glossy



>|< 9 mm
120x180 cm
47.24"x70.86"



cardinal classic

cardinal classic variations
120x180



| CARDINAL CLASSIC | SIZES (cm / inches) | THICKNESS (mm) |
|------------------|-------------------------|-------------------|
| | 120x180 / 47.24"x70.86" | 9 |

Note: For each slab, there will be multiple random faces with different graphic designs of the same genre. For best results of fixing slabs of any size / formats, across any application, please refer to the Maximus Technical Manual in this catalogue. Design images of the product are for illustrative purposes only and may differ in colour and design from the actual product. RAK Ceramics reserves the right to change the colour and the design of any product at its own discretion, without any prior notice.

MARBLE

WILLIAM GREY LEGEND

Vitrified tile
High Glossy



9 mm
120x180 cm
47.24"x70.86"



william grey legend

william grey legend variations
120x180

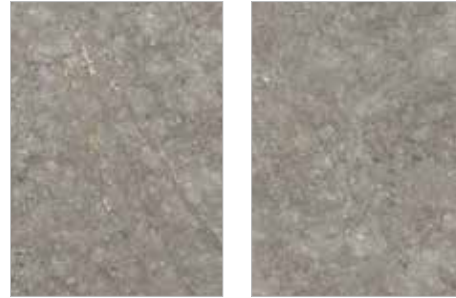

| WILLIAM GREY LEGEND | SIZES (cm / inches) | THICKNESS (mm) |
|---------------------|-------------------------|-------------------|
| | 120x180 / 47.24"x70.86" | 9 |

Note: For each slab, there will be multiple random faces with different graphic designs of the same genre. For best results of fixing slabs of any size / formats, across any application, please refer to the Maximus Technical Manual in this catalogue. Design images of the product are for illustrative purposes only and may differ in colour and design from the actual product. RAK Ceramics reserves the right to change the colour and the design of any product at its own discretion, without any prior notice.

MARBLE

KENTUCKY BEIGE

Vitrified tile
High Glossy



9 mm
120x180 cm
47.24"x70.86"



kentucky beige

kentucky beige variations
120x180



| KENTUCKY BEIGE | SIZES (cm / inches) | THICKNESS (mm) |
|----------------|-------------------------|-------------------|
| | 120x180 / 47.24"x70.86" | 9 |

Note: For each slab, there will be multiple random faces with different graphic designs of the same genre. For best results of fixing slabs of any size / formats, across any application, please refer to the Maximus Technical Manual in this catalogue. Design images of the product are for illustrative purposes only and may differ in colour and design from the actual product. RAK Ceramics reserves the right to change the colour and the design of any product at its own discretion, without any prior notice.

MARBLE

OPAL BROWN

Vitrified tile
High Glossy



> 9 mm
120x180 cm
47.24"x70.86"



opal brown

opal brown variations
120x180

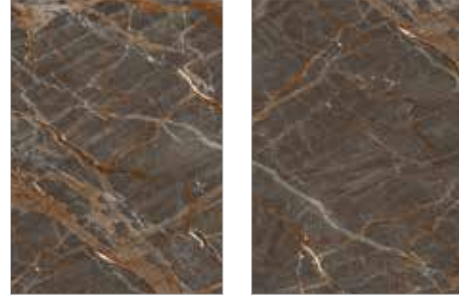

| OPAL BROWN | SIZES (cm / inches) | THICKNESS (mm) |
|------------|-------------------------|-------------------|
| | 120x180 / 47.24"x70.86" | 9 |

Note: For each slab, there will be multiple random faces with different graphic designs of the same genre. For best results of fixing slabs of any size / formats, across any application, please refer to the Maximus Technical Manual in this catalogue. Design images of the product are for illustrative purposes only and may differ in colour and design from the actual product. RAK Ceramics reserves the right to change the colour and the design of any product at its own discretion, without any prior notice.

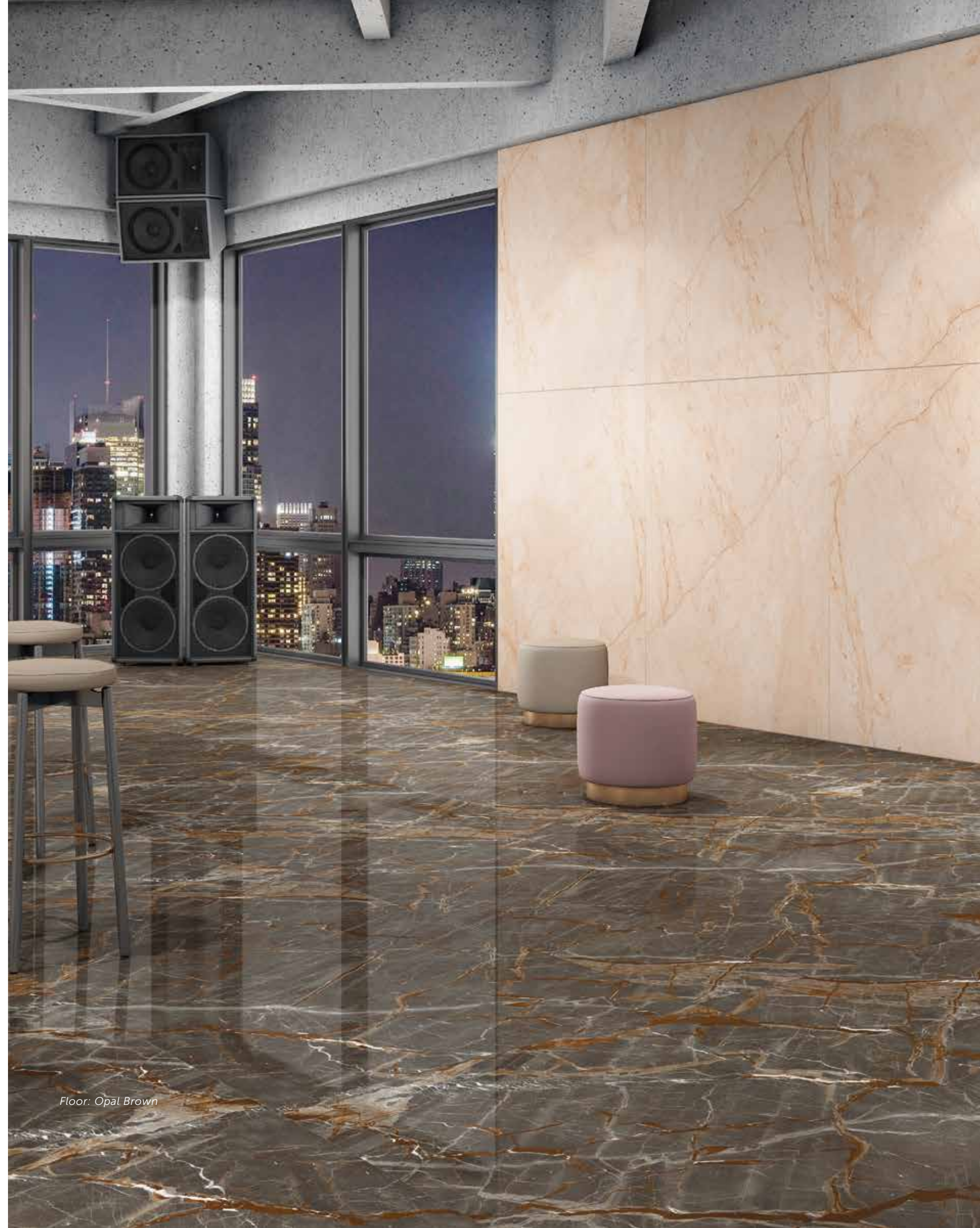

Floor: Opal Brown

MARBLE

FLORENCE BEIGE

Vitrified tile
High Glossy



>|< 9 mm
120x180 cm
47.24"x70.86"



florence beige variations
120x180



florence beige

| FLORENCE BEIGE | SIZES (cm / inches) | THICKNESS (mm) |
|----------------|-------------------------|-------------------|
| | 120x180 / 47.24"x70.86" | 9 |

Note: For each slab, there will be multiple random faces with different graphic designs of the same genre. For best results of fixing slabs of any size / formats, across any application, please refer to the Maximus Technical Manual in this catalogue. Design images of the product are for illustrative purposes only and may differ in colour and design from the actual product. RAK Ceramics reserves the right to change the colour and the design of any product at its own discretion, without any prior notice.

MARBLE

MISSOURI BLUE

Vitrified tile
High Glossy



>|< 9 mm
120x180 cm
47.24"x70.86"



missouri blue variations
120x180



missouri blue

| MISSOURI BLUE | SIZES (cm / inches) | THICKNESS (mm) |
|---------------|-------------------------|-------------------|
| | 120x180 / 47.24"x70.86" | 9 |

Note: For each slab, there will be multiple random faces with different graphic designs of the same genre. For best results of fixing slabs of any size / formats, across any application, please refer to the Maximus Technical Manual in this catalogue. Design images of the product are for illustrative purposes only and may differ in colour and design from the actual product. RAK Ceramics reserves the right to change the colour and the design of any product at its own discretion, without any prior notice.

MARBLE

MICHIGAN BEIGE

Vitrified tile
High Glossy



9 mm
120x180 cm
47.24"x70.86"



michigan beige variations
120x180



michigan beige

| MICHIGAN BEIGE | SIZES (cm / inches) | THICKNESS (mm) |
|----------------|-------------------------|-------------------|
| | 120x180 / 47.24"x70.86" | 9 |

Note: For each slab, there will be multiple random faces with different graphic designs of the same genre. For best results of fixing slabs of any size / formats, across any application, please refer to the Maximus Technical Manual in this catalogue. Design images of the product are for illustrative purposes only and may differ in colour and design from the actual product. RAK Ceramics reserves the right to change the colour and the design of any product at its own discretion, without any prior notice.

MARBLE

HEMROCK GREY

Vitrified tile
High Glossy | Silkmeister



9 mm
120x180 cm
47.24"x70.86"



hemrock grey variations
120x180



hemrock grey

| HEMROCK GREY | SIZES (cm / inches) | THICKNESS (mm) |
|--------------|-------------------------|-------------------|
| | 120x180 / 47.24"x70.86" | 9 |

Note: For each slab, there will be multiple random faces with different graphic designs of the same genre. For best results of fixing slabs of any size / formats, across any application, please refer to the Maximus Technical Manual in this catalogue. Design images of the product are for illustrative purposes only and may differ in colour and design from the actual product. RAK Ceramics reserves the right to change the colour and the design of any product at its own discretion, without any prior notice.

MARBLE

WONDER BROWN

Vitrified tile
High Glossy



>|< 9 mm
120x180 cm
47.24"x70.86"



wonder brown

wonder brown variations
120x180



| WONDER BROWN | SIZES (cm / inches) | THICKNESS (mm) |
|--------------|-------------------------|-------------------|
| | 120x180 / 47.24"x70.86" | 9 |

Note: For each slab, there will be multiple random faces with different graphic designs of the same genre. For best results of fixing slabs of any size / formats, across any application, please refer to the Maximus Technical Manual in this catalogue. Design images of the product are for illustrative purposes only and may differ in colour and design from the actual product. RAK Ceramics reserves the right to change the colour and the design of any product at its own discretion, without any prior notice.



Floor: Wonder Brown

MARBLE

LASA BIANCO

Vitrified tile
High Glossy | Silkmeister



>|< 9 mm
120x180 cm
47.24"x70.86"



lasa bianco

lasa bianco variations
120x180



| LASA BIANCO | SIZES (cm / inches) | THICKNESS (mm) |
|-------------|-------------------------|-------------------|
| | 120x180 / 47.24"x70.86" | 9 |

Note: For each slab, there will be multiple random faces with different graphic designs of the same genre. For best results of fixing slabs of any size / formats, across any application, please refer to the Maximus Technical Manual in this catalogue. Design images of the product are for illustrative purposes only and may differ in colour and design from the actual product. RAK Ceramics reserves the right to change the colour and the design of any product at its own discretion, without any prior notice.

MARBLE

GEORGIA GREY

Vitrified tile
High Glossy | Silkmeister



>|< 9 mm
120x180 cm
47.24"x70.86"



georgia grey

georgia grey variations
120x180

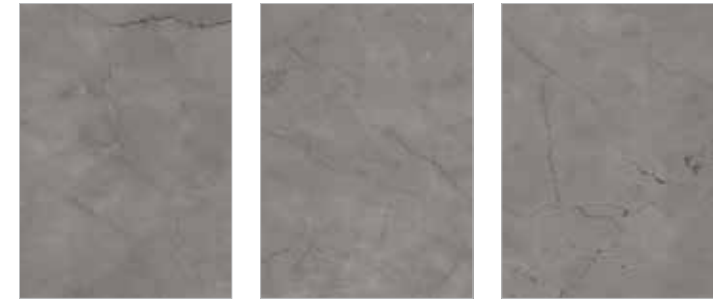

| GEORGIA GREY | SIZES (cm / inches) | THICKNESS (mm) |
|--------------|-------------------------|-------------------|
| | 120x180 / 47.24"x70.86" | 9 |

Note: For each slab, there will be multiple random faces with different graphic designs of the same genre. For best results of fixing slabs of any size / formats, across any application, please refer to the Maximus Technical Manual in this catalogue. Design images of the product are for illustrative purposes only and may differ in colour and design from the actual product. RAK Ceramics reserves the right to change the colour and the design of any product at its own discretion, without any prior notice.

MARBLE

FLORIDA BROWN

Vitrified tile
High Glossy | Silkmeister



>|< 9 mm
120x180 cm
47.24"x70.86"



florida brown

florida brown variations
120x180



| FLORIDA BROWN | SIZES (cm / inches) | THICKNESS (mm) |
|---------------|-------------------------|-------------------|
| | 120x180 / 47.24"x70.86" | 9 |

Note: For each slab, there will be multiple random faces with different graphic designs of the same genre. For best results of fixing slabs of any size / formats, across any application, please refer to the Maximus Technical Manual in this catalogue. Design images of the product are for illustrative purposes only and may differ in colour and design from the actual product. RAK Ceramics reserves the right to change the colour and the design of any product at its own discretion, without any prior notice.

MARBLE

MONTANA BEIGE

Vitrified tile
High Glossy



>|< 9 mm
120x180 cm
47.24"x70.86"



montana beige

montana beige variations
120x180



| MONTANA BEIGE | SIZES (cm / inches) | THICKNESS (mm) |
|---------------|-------------------------|-------------------|
| | 120x180 / 47.24"x70.86" | 9 |

Note: For each slab, there will be multiple random faces with different graphic designs of the same genre. For best results of fixing slabs of any size / formats, across any application, please refer to the Maximus Technical Manual in this catalogue. Design images of the product are for illustrative purposes only and may differ in colour and design from the actual product. RAK Ceramics reserves the right to change the colour and the design of any product at its own discretion, without any prior notice.

MARBLE

NEW JERSEY GREY

Vitrified tile
Silkmeister



>|< 9 mm
120x180 cm
47.24"x70.86"

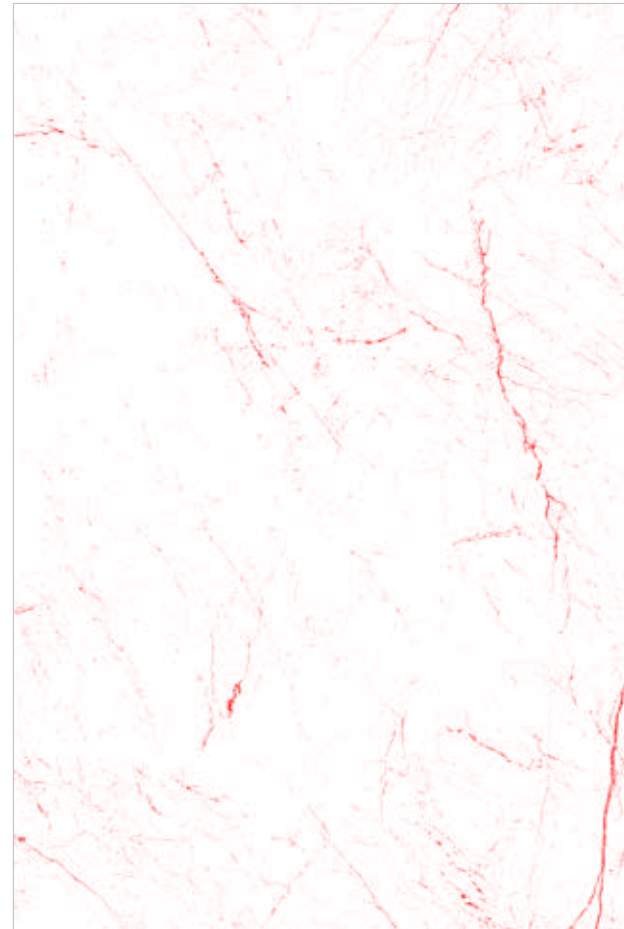

new jersey grey

new jersey grey variations
120x180

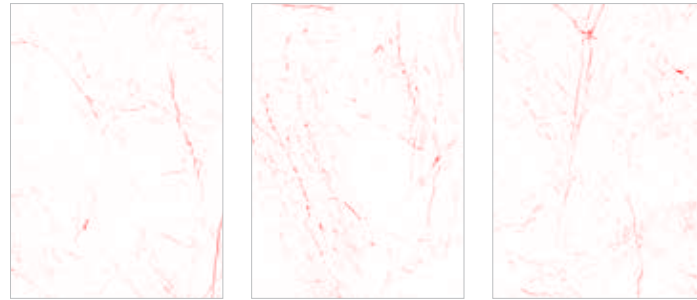

| NEW JERSEY GREY | SIZES (cm / inches) | THICKNESS (mm) |
|-----------------|-------------------------|-------------------|
| | 120x180 / 47.24"x70.86" | 9 |

Note: For each slab, there will be multiple random faces with different graphic designs of the same genre. For best results of fixing slabs of any size / formats, across any application, please refer to the Maximus Technical Manual in this catalogue. Design images of the product are for illustrative purposes only and may differ in colour and design from the actual product. RAK Ceramics reserves the right to change the colour and the design of any product at its own discretion, without any prior notice.

MARBLE

NEVADA GREY

Vitrified tile
Silkmeister



>|< 9 mm
120x180 cm
47.24"x70.86"



nevada grey

nevada grey variations
120x180

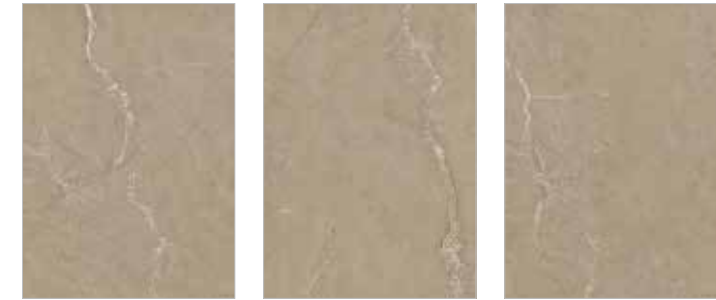

| NEVADA GREY | SIZES (cm / inches) | THICKNESS (mm) |
|-------------|-------------------------|-------------------|
| | 120x180 / 47.24"x70.86" | 9 |

Note: For each slab, there will be multiple random faces with different graphic designs of the same genre. For best results of fixing slabs of any size / formats, across any application, please refer to the Maximus Technical Manual in this catalogue. Design images of the product are for illustrative purposes only and may differ in colour and design from the actual product. RAK Ceramics reserves the right to change the colour and the design of any product at its own discretion, without any prior notice.

MARBLE

CAROLINA GREY

Vitrified tile
Silkmeister



>|< 9 mm
120x180 cm
47.24"x70.86"



carolina grey

carolina grey variations
120x180



| CAROLINA GREY | SIZES (cm / inches) | THICKNESS (mm) |
|---------------|-------------------------|-------------------|
| | 120x180 / 47.24"x70.86" | 9 |

Note: For each slab, there will be multiple random faces with different graphic designs of the same genre. For best results of fixing slabs of any size / formats, across any application, please refer to the Maximus Technical Manual in this catalogue. Design images of the product are for illustrative purposes only and may differ in colour and design from the actual product. RAK Ceramics reserves the right to change the colour and the design of any product at its own discretion, without any prior notice.

MARBLE

DELAWARE GREY

Vitrified tile
Silkmeister



>|< 9 mm
120x180 cm
47.24"x70.86"



delaware grey

delaware grey variations
120x180

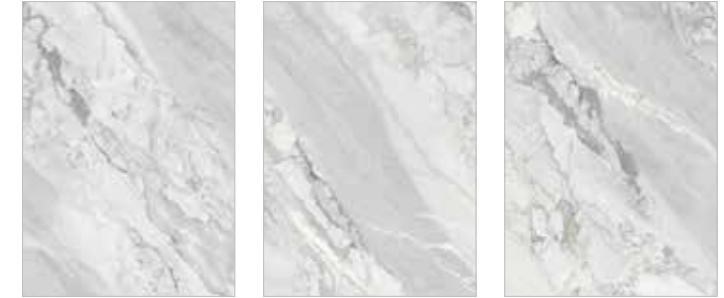

| DELAWARE GREY | SIZES (cm / inches) | THICKNESS (mm) |
|---------------|-------------------------|-------------------|
| | 120x180 / 47.24"x70.86" | 9 |

Note: For each slab, there will be multiple random faces with different graphic designs of the same genre. For best results of fixing slabs of any size / formats, across any application, please refer to the Maximus Technical Manual in this catalogue. Design images of the product are for illustrative purposes only and may differ in colour and design from the actual product. RAK Ceramics reserves the right to change the colour and the design of any product at its own discretion, without any prior notice.

MARBLE

DOVER BROWN

Vitrified tile
Silkmeister



>|< 9 mm
120x180 cm
47.24"x70.86"



dover brown

dover brown variations
120x180



| DOVER BROWN | SIZES (cm / inches) | THICKNESS (mm) |
|-------------|-------------------------|-------------------|
| | 120x180 / 47.24"x70.86" | 9 |

Note: For each slab, there will be multiple random faces with different graphic designs of the same genre. For best results of fixing slabs of any size / formats, across any application, please refer to the Maximus Technical Manual in this catalogue. Design images of the product are for illustrative purposes only and may differ in colour and design from the actual product. RAK Ceramics reserves the right to change the colour and the design of any product at its own discretion, without any prior notice.

MARBLE

FRANKLIN BEIGE

Vitrified tile
Silkmeister



>|< 9 mm
120x180 cm
47.24"x70.86"



franklin beige

franklin beige variations
120x180



| FRANKLIN BEIGE | SIZES (cm / inches) | THICKNESS (mm) |
|----------------|-------------------------|-------------------|
| | 120x180 / 47.24"x70.86" | 9 |

Note: For each slab, there will be multiple random faces with different graphic designs of the same genre. For best results of fixing slabs of any size / formats, across any application, please refer to the Maximus Technical Manual in this catalogue. Design images of the product are for illustrative purposes only and may differ in colour and design from the actual product. RAK Ceramics reserves the right to change the colour and the design of any product at its own discretion, without any prior notice.

MARBLE

SCANDINAVIAN GREY

Vitrified tile
Carving



>|< 9 mm
120x180 cm
47.24"x70.86"



scandinavian grey

scandinavian grey variations
120x180



| SCANDINAVIAN GREY | SIZES (cm / inches) | THICKNESS (mm) |
|-------------------|-------------------------|-------------------|
| | 120x180 / 47.24"x70.86" | 9 |

Note: For each slab, there will be multiple random faces with different graphic designs of the same genre. For best results of fixing slabs of any size / formats, across any application, please refer to the Maximus Technical Manual in this catalogue. Design images of the product are for illustrative purposes only and may differ in colour and design from the actual product. RAK Ceramics reserves the right to change the colour and the design of any product at its own discretion, without any prior notice.

MARBLE

IRISH GREY

Vitrified tile
Carving



>|< 9 mm
120x180 cm
47.24"x70.86"



irish grey

irish grey variations
120x180

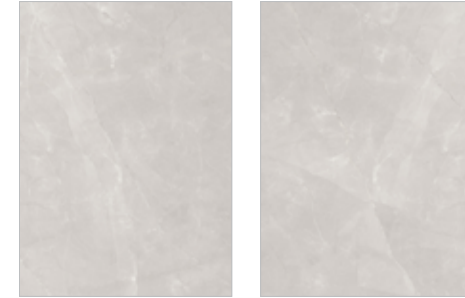

| IRISH GREY | SIZES (cm / inches) | THICKNESS (mm) |
|------------|-------------------------|-------------------|
| | 120x180 / 47.24"x70.86" | 9 |

Note: For each slab, there will be multiple random faces with different graphic designs of the same genre. For best results of fixing slabs of any size / formats, across any application, please refer to the Maximus Technical Manual in this catalogue. Design images of the product are for illustrative purposes only and may differ in colour and design from the actual product. RAK Ceramics reserves the right to change the colour and the design of any product at its own discretion, without any prior notice.

MARBLE

MINNESOTA BARLEY

Vitrified tile
Carving



>|< 9 mm
120x180 cm
47.24"x70.86"



minnesota barley

minnesota barley variations
120x180



| MINNESOTA BARLEY | SIZES (cm / inches) | THICKNESS (mm) |
|------------------|-------------------------|-------------------|
| | 120x180 / 47.24"x70.86" | 9 |

Note: For each slab, there will be multiple random faces with different graphic designs of the same genre. For best results of fixing slabs of any size / formats, across any application, please refer to the Maximus Technical Manual in this catalogue. Design images of the product are for illustrative purposes only and may differ in colour and design from the actual product. RAK Ceramics reserves the right to change the colour and the design of any product at its own discretion, without any prior notice.

MARBLE

MINNESOTA BLACK

Vitrified tile
Carving



>|< 9 mm
120x180 cm
47.24"x70.86"



minnesota black

minnesota black variations
120x180

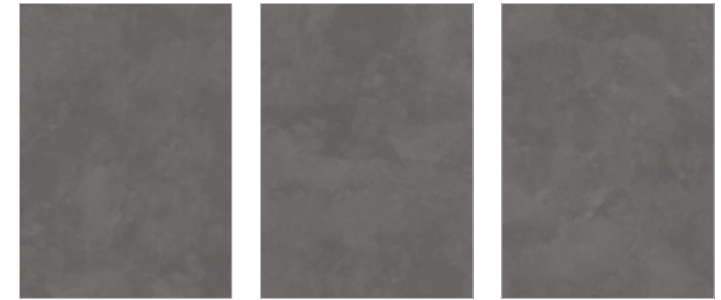

| MINNESOTA BLACK | SIZES (cm / inches) | THICKNESS (mm) |
|-----------------|-------------------------|-------------------|
| | 120x180 / 47.24"x70.86" | 9 |

Note: For each slab, there will be multiple random faces with different graphic designs of the same genre. For best results of fixing slabs of any size / formats, across any application, please refer to the Maximus Technical Manual in this catalogue. Design images of the product are for illustrative purposes only and may differ in colour and design from the actual product. RAK Ceramics reserves the right to change the colour and the design of any product at its own discretion, without any prior notice.

MARBLE

MINNESOTA GREY

Vitrified tile
Carving



>|< 9 mm
120x180 cm
47.24"x70.86"



minnesota grey

minnesota grey variations
120x180



| MINNESOTA GREY | SIZES (cm / inches) | THICKNESS (mm) |
|----------------|-------------------------|-------------------|
| | 120x180 / 47.24"x70.86" | 9 |

Note: For each slab, there will be multiple random faces with different graphic designs of the same genre. For best results of fixing slabs of any size / formats, across any application, please refer to the Maximus Technical Manual in this catalogue. Design images of the product are for illustrative purposes only and may differ in colour and design from the actual product. RAK Ceramics reserves the right to change the colour and the design of any product at its own discretion, without any prior notice.

MARBLE

MINNESOTA TAUPE

Vitrified tile
Carving



>|< 9 mm
120x180 cm
47.24"x70.86"



minnesota taupe

minnesota taupe variations
120x180



| MINNESOTA TAUPE | SIZES (cm / inches) | THICKNESS (mm) |
|-----------------|-------------------------|-------------------|
| | 120x180 / 47.24"x70.86" | 9 |

Note: For each slab, there will be multiple random faces with different graphic designs of the same genre. For best results of fixing slabs of any size / formats, across any application, please refer to the Maximus Technical Manual in this catalogue. Design images of the product are for illustrative purposes only and may differ in colour and design from the actual product. RAK Ceramics reserves the right to change the colour and the design of any product at its own discretion, without any prior notice.

MARBLE

MINNESOTA ALMOND

Vitrified tile
Carving



 **> 9 mm**
120x180 cm
47.24"x70.86"



minnesota almond

minnesota almond variations
120x180



| MINNESOTA ALMOND | SIZES (cm / inches) | THICKNESS (mm) |
|------------------|-------------------------|-------------------|
| | 120x180 / 47.24"x70.86" | 9 |

Note: For each slab, there will be multiple random faces with different graphic designs of the same genre. For best results of fixing slabs of any size / formats, across any application, please refer to the Maximus Technical Manual in this catalogue. Design images of the product are for illustrative purposes only and may differ in colour and design from the actual product. RAK Ceramics reserves the right to change the colour and the design of any product at its own discretion, without any prior notice.



Floor: Minnesota Almond

MARBLE

RHAPSODY LT BROWN

Vitrified tile
Carving



>|< 9 mm
120x180 cm
47.24"x70.86"



rhapsody lt brown

rhapsody lt brown variations
120x180



| RHAPSODY LT BROWN | SIZES (cm / inches) | THICKNESS (mm) |
|-------------------|-------------------------|-------------------|
| | 120x180 / 47.24"x70.86" | 9 |

Note: For each slab, there will be multiple random faces with different graphic designs of the same genre. For best results of fixing slabs of any size / formats, across any application, please refer to the Maximus Technical Manual in this catalogue. Design images of the product are for illustrative purposes only and may differ in colour and design from the actual product. RAK Ceramics reserves the right to change the colour and the design of any product at its own discretion, without any prior notice.

MARBLE

RHAPSODY BROWN

Vitrified tile
Carving



>|< 9 mm
120x180 cm
47.24"x70.86"



rhapsody brown

rhapsody brown variations
120x180



| RHAPSODY BROWN | SIZES (cm / inches) | THICKNESS (mm) |
|----------------|-------------------------|-------------------|
| | 120x180 / 47.24"x70.86" | 9 |

Note: For each slab, there will be multiple random faces with different graphic designs of the same genre. For best results of fixing slabs of any size / formats, across any application, please refer to the Maximus Technical Manual in this catalogue. Design images of the product are for illustrative purposes only and may differ in colour and design from the actual product. RAK Ceramics reserves the right to change the colour and the design of any product at its own discretion, without any prior notice.

MARBLE

RHAPSODY AVORIO

Vitrified tile
Carving



> 9 mm
120x180 cm
47.24"x70.86"



rhapsody avorio

rhapsody avorio variations
120x180



| RHAPSODY AVORIO | SIZES (cm / inches) | THICKNESS (mm) |
|-----------------|-------------------------|-------------------|
| | 120x180 / 47.24"x70.86" | 9 |

Note: For each slab, there will be multiple random faces with different graphic designs of the same genre. For best results of fixing slabs of any size / formats, across any application, please refer to the Maximus Technical Manual in this catalogue. Design images of the product are for illustrative purposes only and may differ in colour and design from the actual product. RAK Ceramics reserves the right to change the colour and the design of any product at its own discretion, without any prior notice.



Floor: Rhapsody Avorio

SURFACE XL 238

BASIC CONCRETE XL GREY 239

MEGALITH 240

EURO ELEGANTE 241

COLERIDGE 242

CONRAD CEMENT 243

SIGNUM 244

CONCRETE





CONCRETE

Maximus' concrete collections make a powerful statement with their sheer simplicity. No fuss, no frills, just pure perfection. Packed full of contemporary style, the concrete effect big slabs are the ideal choice for creating a minimalist look and feel.

Applied on furniture or indoor and outdoor cladding, the Maximus solutions are strikingly bold and beautiful, inspired by the simplicity and strength of industrial concrete.



Floor: Coleridge Dark Grey
Wall: Coleridge Dark Grey



Floor: Conrad Cement Light Grey
Wall: Conrad Cement Light Grey



Floor: Conrad Cement Dark Grey



Floor: Surface Night



Floor: Surface Sand

CONCRETE

SURFACE XL

Vitrified tile
Hard Matt | Matt



cool grey



night



off white



sand

> 9 mm
120x240 cm
47.24"x94.48"

> 9 mm
120x120 cm
47.24"x47.24"

> 9 mm
80x160 cm
31.49"x63"



cool grey



night



off white



sand

| SIZES (cm / inches) | THICKNESS (mm) |
|-------------------------|-------------------|
| 120x120 / 47.24"x47.24" | 9 |
| 80x160 / 31.49"x63" | 9 |

| SIZES (cm / inches) | THICKNESS (mm) |
|-------------------------|-------------------|
| 120x240 / 47.24 "x94.5" | 9 |

| SIZES (cm / inches) | THICKNESS (mm) |
|-------------------------|-------------------|
| 120x240 / 47.24 "x94.5" | 9 |
| 120x120 / 47.24"x47.24" | 9 |

| SIZES (cm / inches) | THICKNESS (mm) |
|-------------------------|-------------------|
| 120x120 / 47.24"x47.24" | 9 |

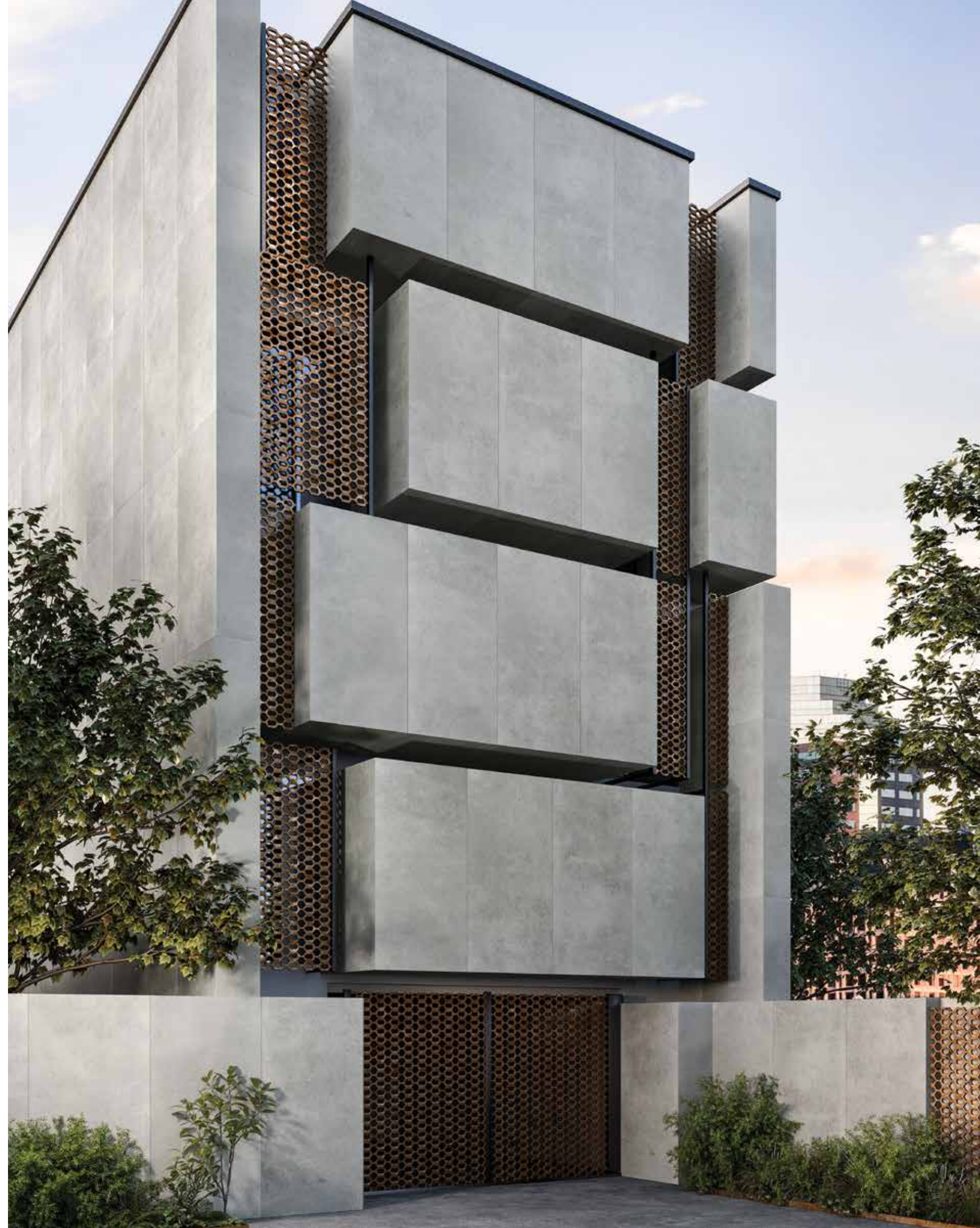

Note: For each slab, there will be multiple random faces with different graphic designs of the same genre. For best results of fixing slabs of any size / formats, across any application, please refer to the Maximus Technical Manual in this catalogue. Design images of the product are for illustrative purposes only and may differ in colour and design from the actual product. RAK Ceramics reserves the right to change the colour and the design of any product at its own discretion, without any prior notice.

CONCRETE

BASIC CONCRETE XL GREY

Vitrified tile
Matt



>|< 9 mm
120x240 cm
47.24"x94.48"

>|< 9 mm
120x120 cm
47.24"x47.24"



xl grey

| SIZES (cm / inches) | THICKNESS (mm) |
|-------------------------|-------------------|
| 120x120 / 47.24"x47.24" | 9 |

MEGALITH

Vitrified tile
Matt



>|< 9 mm
120x120 cm
47.24"x47.24"



gris

| SIZES (cm / inches) | THICKNESS (mm) |
|-------------------------|-------------------|
| 120x120 / 47.24"x47.24" | 9 |

Note: For each slab, there will be multiple random faces with different graphic designs of the same genre. For best results of fixing slabs of any size / formats, across any application, please refer to the Maximus Technical Manual in this catalogue. Design images of the product are for illustrative purposes only and may differ in colour and design from the actual product. RAK Ceramics reserves the right to change the colour and the design of any product at its own discretion, without any prior notice.

EURO ELEGANTE

Vitrified tile
Matt



ash

bianco

>|< 9 mm
120x120 cm
47.24"x47.24"

>|< 9 mm
80x160 cm
31.49"x63"



ash

| SIZES (cm / inches) | THICKNESS (mm) |
|------------------------|-------------------|
| 80x160 / 31.49"x63" | 9 |



bianco

| SIZES (cm / inches) | THICKNESS (mm) |
|-------------------------|-------------------|
| 120x120 / 47.24"x47.24" | 9 |
| 80x160 / 31.49"x63" | 9 |

Note: For each slab, there will be multiple random faces with different graphic designs of the same genre. For best results of fixing slabs of any size / formats, across any application, please refer to the Maximus Technical Manual in this catalogue. Design images of the product are for illustrative purposes only and may differ in colour and design from the actual product. RAK Ceramics reserves the right to change the colour and the design of any product at its own discretion, without any prior notice.

CONCRETE

COLERIDGE

Vitrified tile
Soft Matt



>|< 9 mm
80x160 cm
31.49"x63"



beige



light grey



dark grey

| SIZES (cm / inches) | THICKNESS (mm) |
|------------------------|-------------------|
| 80x160 / 31.49"x63" | 9 |

| SIZES (cm / inches) | THICKNESS (mm) |
|------------------------|-------------------|
| 80x160 / 31.49"x63" | 9 |

| SIZES (cm / inches) | THICKNESS (mm) |
|------------------------|-------------------|
| 80x160 / 31.49"x63" | 9 |

Note: For each slab , there will be multiple random faces with different graphic designs of the same genre. For best results of fixing slabs of any size / formats, across any application , please refer to the Maximus Technical Manual in this catalogue. Design images of the product are for illustrative purposes only and may differ in colour and design from the actual product. RAK Ceramics reserves the right to change the colour and the design of any product at its own discretion, without any prior notice.

CONRAD CEMENT

Vitrified tile
Soft Matt



>|< 9 mm
80x160 cm
31.49"x63"



light grey



dark Grey

| SIZES (cm / inches) | THICKNESS (mm) |
|------------------------|-------------------|
| 80x160 / 31.49"x63" | 9 |

| SIZES (cm / inches) | THICKNESS (mm) |
|------------------------|-------------------|
| 80x160 / 31.49"x63" | 9 |

Note: For each slab , there will be multiple random faces with different graphic designs of the same genre. For best results of fixing slabs of any size / formats, across any application , please refer to the Maximus Technical Manual in this catalogue. Design images of the product are for illustrative purposes only and may differ in colour and design from the actual product. RAK Ceramics reserves the right to change the colour and the design of any product at its own discretion, without any prior notice.

STONE

SIGNUM

Vitrified tile
Matt



>|< 9 mm
120x120 cm
47.24"x47.24"

>|< 9 mm
80x160 cm
31.49"x63"



clair

| SIZES (cm / inches) | THICKNESS (mm) |
|-------------------------|-------------------|
| 120x120 / 47.24"x47.24" | 9 |
| 80x160 / 31.49"x63" | 9 |

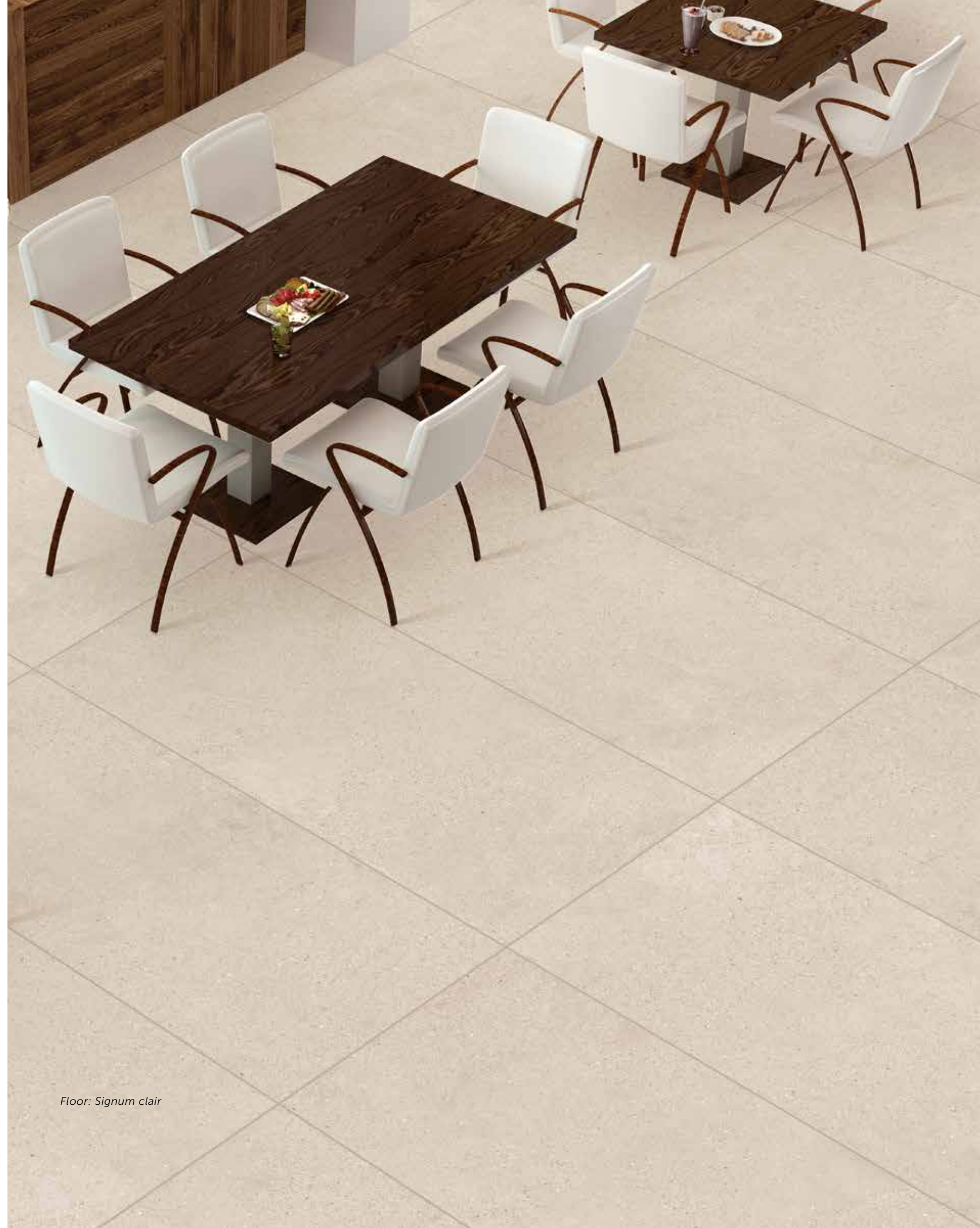

Floor: Signum clair

Note: For each slab, there will be multiple random faces with different graphic designs of the same genre. For best results of fixing slabs of any size / formats, across any application, please refer to the Maximus Technical Manual in this catalogue. Design images of the product are for illustrative purposes only and may differ in colour and design from the actual product. RAK Ceramics reserves the right to change the colour and the design of any product at its own discretion, without any prior notice.

ICON METAL BROWN 252

ICON METAL LIGHT GREY 252

IGNAZIO BROWN 253



METAL



METAL

Maximus celebrates the dramatic effects and contrasting colours created during the ageing process of raw metal. With a bold and arresting appearance, the Metal collection is perfect for urban and industrial settings and is suitable for indoor and outdoor applications.



Floor: Ignazio Brown

METAL

ICON METAL BROWN

Vitrified tile
Lappato



>|< 9 mm
120x240 cm
47.24"x94.48"



icon metal brown

| SIZES (cm / inches) | THICKNESS (mm) |
|-------------------------|-------------------|
| 120x240 / 47.24"x94.48" | 9 |

METAL

IGNAZIO BROWN

Vitrified tile
Soft Matt



>|< 9 mm
120x240 cm
47.24"x94.48"



ignazio brown

| SIZES (cm / inches) | THICKNESS (mm) |
|-------------------------|-------------------|
| 120x240 / 47.24 "x94.5" | 9 |

ICON METAL LIGHT GREY

Vitrified tile
Lappato



>|< 9 mm
120x120 cm
47.24"x47.24"



icon metal light grey

| SIZES (cm / inches) | THICKNESS (mm) |
|-------------------------|-------------------|
| 120x120 / 47.24"x47.24" | 9 |

Note: For each slab, there will be multiple random faces with different graphic designs of the same genre. For best results of fixing slabs of any size / formats, across any application, please refer to the Maximus Technical Manual in this catalogue. Design images of the product are for illustrative purposes only and may differ in colour and design from the actual product. RAK Ceramics reserves the right to change the colour and the design of any product at its own discretion, without any prior notice.

Note: For each slab, there will be multiple random faces with different graphic designs of the same genre. For best results of fixing slabs of any size / formats, across any application, please refer to the Maximus Technical Manual in this catalogue. Design images of the product are for illustrative purposes only and may differ in colour and design from the actual product. RAK Ceramics reserves the right to change the colour and the design of any product at its own discretion, without any prior notice.

HOPPER 258

STONE

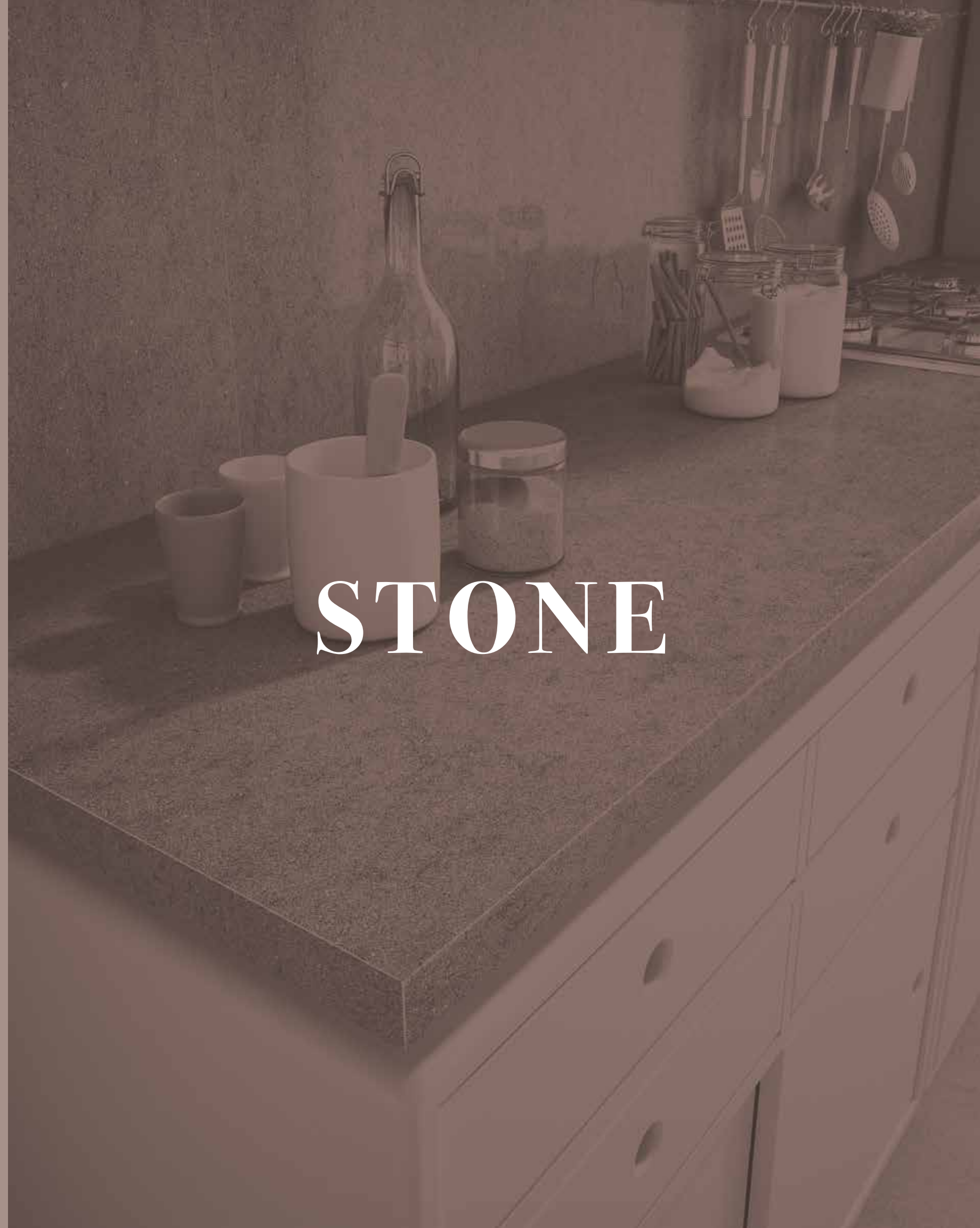



STONE

Maximus reinterprets the ancestral charm of stone and transforms it in one of the most favorite material in contemporary architecture.

Solid, durable and extremely versatile.

Maximus stones can be applied both indoors and out, and are designed to interpret both more minimalist tastes as well as the more refined and stylish ones.

FULL BODY

HOPPER

Vitrified tile
Matt

>k 9 mm
80x160 cm
31.49"x63"



grey

| SIZES (cm / inches) | THICKNESS (mm) |
|------------------------|-------------------|
| 80x160 / 31.49"x63" | 9 |

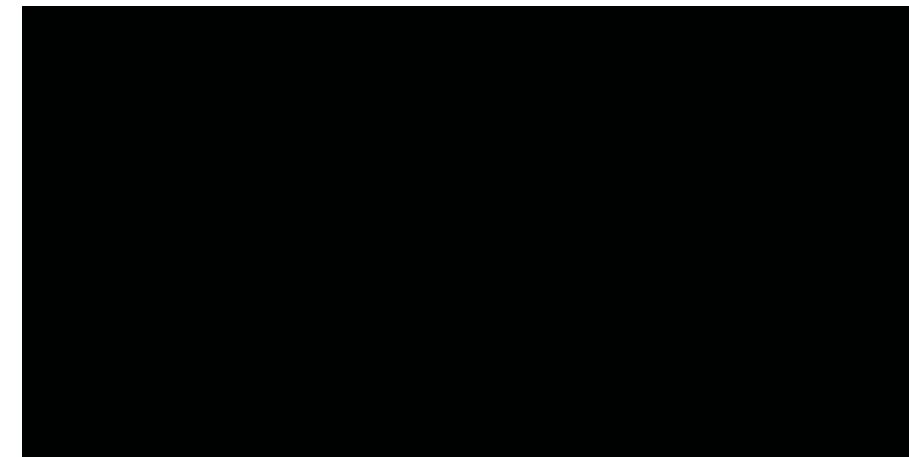

black

| SIZES (cm / inches) | THICKNESS (mm) |
|------------------------|-------------------|
| 80x160 / 31.49"x63" | 9 |



kota

| SIZES (cm / inches) | THICKNESS (mm) |
|------------------------|-------------------|
| 80x160 / 31.49"x63" | 9 |



mocha

| SIZES (cm / inches) | THICKNESS (mm) |
|------------------------|-------------------|
| 80x160 / 31.49"x63" | 9 |

Note: For each slab, there will be multiple random faces with different graphic designs of the same genre. For best results of fixing slabs of any size / formats, across any application, please refer to the Maximus Technical Manual in this catalogue. Design images of the product are for illustrative purposes only and may differ in colour and design from the actual product. RAK Ceramics reserves the right to change the colour and the design of any product at its own discretion, without any prior notice.

Note: For each slab, there will be multiple random faces with different graphic designs of the same genre. For best results of fixing slabs of any size / formats, across any application, please refer to the Maximus Technical Manual in this catalogue. Design images of the product are for illustrative purposes only and may differ in colour and design from the actual product. RAK Ceramics reserves the right to change the colour and the design of any product at its own discretion, without any prior notice.



TECHNICAL MANUAL

PRODUCT TYPOLOGY & SIZES

TECHNICAL SPECIFICATIONS

HANDLING

INSTALLATION (WALL, FLOOR AND FAÇADE)

CLEANING AND MAINTENANCE

Product sizes

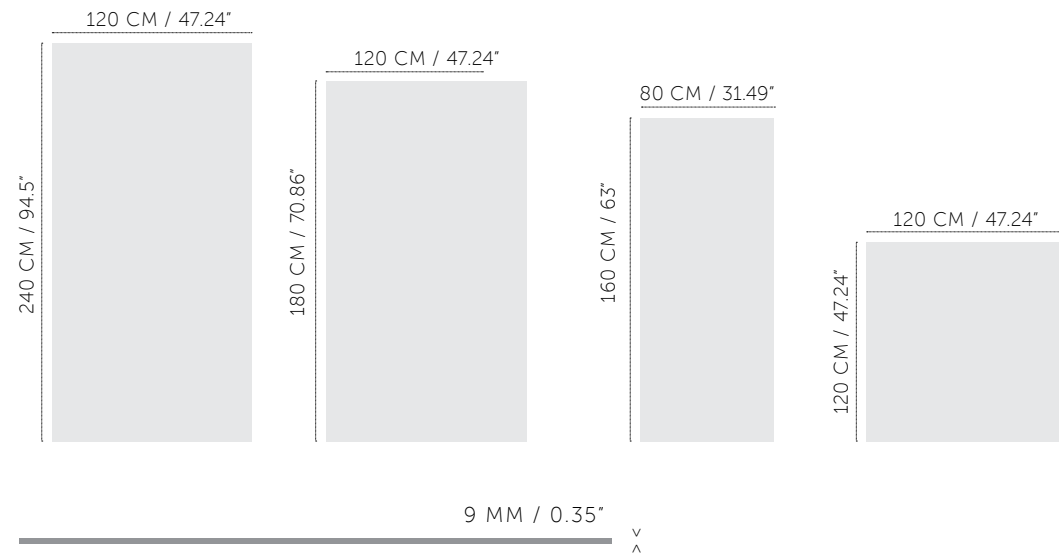

PRODUCT TYPOLOGY

| BODY TYPE | SIZE (CM) | POLISHED & HIGH GLOSSY | SILKMEISTER | MATT | CARVING | BABY SKIN | 9MM THICK |
|---------------------------|-----------|------------------------|-------------|------|---------|-----------|-----------|
| Vitrified Tiles | 120X240 | ✓ | ✗ | ✓ | ✗ | ✗ | ✓ |
| Vitrified Tiles | 120X120 | ✓ | ✗ | ✓ | ✗ | ✗ | ✓ |
| Vitrified Tiles | 120X180 | ✓ | ✓ | ✗ | ✓ | ✗ | ✓ |
| Vitrified Tiles | 80X160 | ✓ | ✗ | ✓ | ✓ | ✓ | ✓ |
| Full Body Vitrified Tiles | 80X160 | ✗ | ✗ | ✓ | ✗ | ✗ | ✓ |

Technical specifications - Vitrified Tile

GVT/PGVT

| TEST DESCRIPTION | STANDARD TEST METHOD | STANDARD REQUIREMENTS | RAK CERAMICS SPECIFICATION |
|---|----------------------|--------------------------------------|-----------------------------------|
| Deviation in Length | BS EN ISO 10545 - 2 | ±0.3 % | ±0.10 % |
| Deviation in Width | BS EN ISO 10545 - 2 | ±0.3% | ±0.10 % |
| Deviation in Thickness | BS EN ISO 10545-2 | ±5.0 % | ±4.00% |
| Straightness of Sides | BS EN ISO 10545 - 2 | ±0.3% | ±0.10 % |
| Rectangularity (mm) | BS EN ISO 10545 - 2 | ±0.3 % | ±0.10 % |
| Surface flatness : Center curvature | BS EN ISO 10545 - 2 | ± 0.40 % | ±0.20 % |
| Surface flatness : Edge curvature | BS EN ISO 10545-2 | ± 0.40 % | ± 0.20 % |
| Surface flatness : Warpage | BS EN JSO 10545-2 | ± 0.40 % | ± 0.20 % |
| Surface Quality | BS EN ISO 10545 - 2 | Min 95% free from visible defects | Min 95% free from visible defects |
| Water Absorption | BS EN ISO 10545 - 3 | Ev ≤0.5 % | ≤ 0.05 % |
| Breaking Strength | BS EN ISO 10545 - 4 | ≤ 1300 N | ≥ 1600 N |
| Modules Of Rupture | BS EN ISO 10545 - 4 | ≥ 35 N/mm ² | ≥ 38 N/mm ² |
| Resistance to surface Abrasion for glazed tiles | BS EN ISO 10545- 7 | Report abrasion class | PEI-2-4 |
| Co Efficient Of Linear Thermal Expansion | BS EN ISO 10545- 8 | Test method available | < 7x 10 ⁻⁶ /°C |
| Thennal Shock Resistance | BS EN ISO I 0545 - 9 | Test method available | No visible defect |
| Crazing Resistance | BS EN ISO 10545- 11 | Required | 4 Cycle Pass |
| Frost- Resistance | BS EN ISO 10545 - 12 | Required | No visible damage |
| Resistance to House hold Chemicals & swimming pool Salts | BS EN ISO 10545 - 13 | MinimumB | Class A No visible effect |
| Resistance to acids & alkalis (with exceptions of HF acid and it's compounds) | BS EN ISO 10545,- 13 | Manufacturer to state classification | Class LA No visible effect |
| Resistance To Staining | BS EN ISO 10545- 14 | Min Class-3 | Min Class-3 |

Note: The Breaking Strength & MOR values shall be as per RAK INDIA (Morbi) Lab MOR testing machine results Test Performed using 90x90 cm cut pieces from the slab.

Superior quality raw materials like kaolin, clay, feldspar, silica, and colouring inks are imported from Europe and other parts of the world to manufacture Maximus Mega Slabs, without compromising on its breaking strength, water absorption, dust, termite and chemical resistance.

Maximus Mega Slabs are exceptionally hard, resist thermal shock better than any material available today, are virtually non-porous and are a green product. Installation is quicker and easier because of the dimensions of the product.

Flooring, wall cladding, kitchen counter tops, vanity tops, steps and risers, and bath surrounds are all possible.

Suggested equipment

HANDLING EQUIPMENT

Aluminum Parallel profile with crossbars and Suction Vacuum suction cups with vacuum gauge



Tile Cart Trolley



Double Suction Cups



Modular Work Bench BM180



Modular Work Bench BM180 BM180 Plus (Perfect Workstation for large format tiles up to 160cm width)



CUTTING AND DRILLING EQUIPMENT

Compass device with suction cups for Circular Cuts



Free cut guide with complete outfit Max. Cut of length – 156 cm



Free Cut Extension



Cutting off pliers for tile/slabs



Diamond polishing pad



Diamond for edge and side polishing



Diamond Blades for simultaneous cutting and grooving

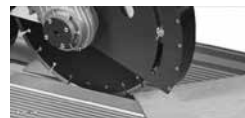

INSTALLATION AND LEVELLING EQUIPMENT

Compact Vibrator or Tile Beater



RLS 3D Clips for tiles



Wedges (for Anti-Chipping / Anti-Scratching preventing platforms)

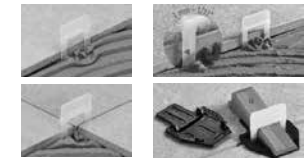

Adjustable pliers for wall and floor covering



Low-speed mixer



Rubber Grout floats



Slant ridge notched trowel



Diamond for edge and side polishing



CLEANING AND MAINTENANCE

Brooms



Floats with abrasive pads



Handling Maximus

- Maximus extra-large format slabs arrive in oversized crates, which require specific Handling equipment to prevent from damage occurring during forklift operation, specific fork sizes must be used. For example, to handle a crate of 135cm x 305cm tiles from the side, 112cm/ 44" long forks are recommended.
- To handle the same crate from the narrow end requires forks that are at least 213cm/ 84" long. Lifting multiple crates with longer forks may require forklifts with a greater lift capacity.
- Specialized tools and equipment are currently available for the handling, installation and cutting of large porcelain surfaces. Innovative trowels with unique notch configurations can help increase the consistency of the mortar coverage on the back of the tile.
- To increase rigidity and limit twisting, use a system composed of parallel and transverse guides.
- For a perfect adhesion clean the slab and the suckers with a damp sponge.
- The suckers run along the guides and adhere to the slab. Make sure that a vacuum is created between the device and the surface.
- A single guide device can be used for sizes of maximum length.
- Use four operators at a time to carry out handling operations of large size slabs.
- Lift the slab along the long side and hang it vertically to the handles of the frame.
- For the large size slab a suitably reinforced trolley is recommended. Set the guides to the trolley for carrying the slab.
- Follow the same procedure for handling the 120x240cm and all other sub-sizes, where only two operators are sufficient.

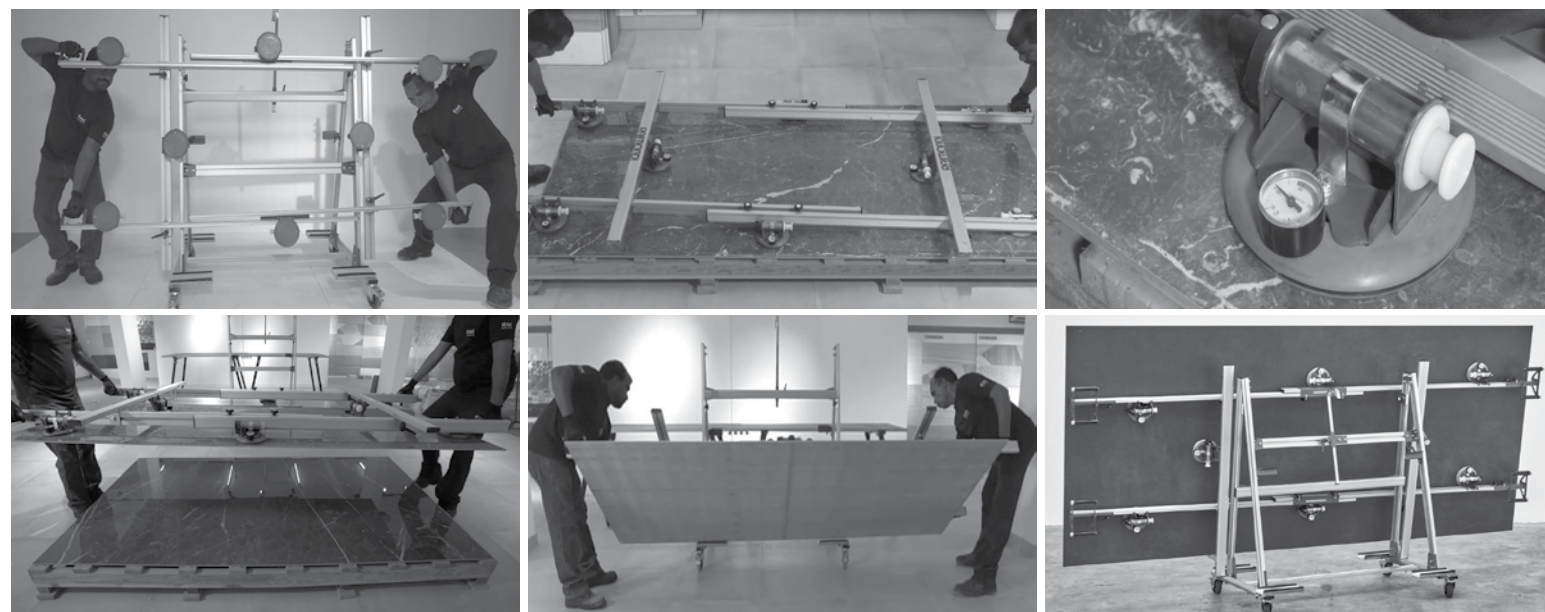
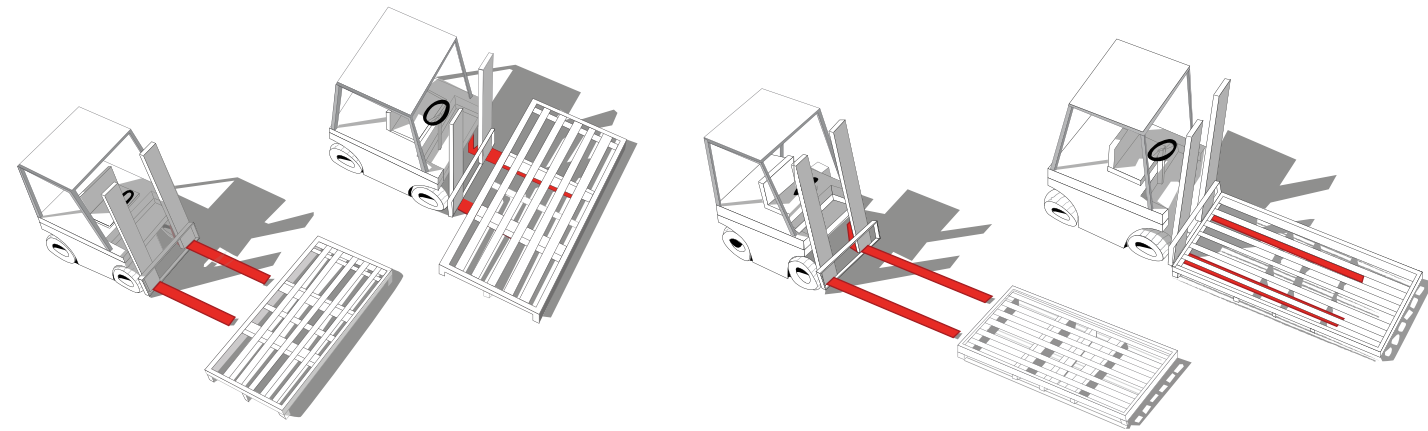

Cut-to-pieces and drilling

- RAK Ceramics recommends the use of special designed devices for handling as well as cutting and laying of big slabs.
- Handle slab with a proper and professional trolley of aluminum parallel profile with crossbars and vacuum suction cups along with a vacuum gauge. Please use double suction cups for slabs above 300cm. This could make sure that appropriate vacuum is created between the device and the slab. Lift the slab and keep it vertically to the trolley frame.
- Keep the slab on a stable, flat and intractable surface. For successful cutting and drilling, RAK Ceramic recommend using a professional modular workbench with aluminum profiles and proper cutting tools for each type of cut.
- Set the cutting unit on the tile so that the references coincide with the marked lines and lock it with the appropriate suckers. Score the slab from one edge to the other, being carefully maintaining the same pressure while moving.
- When the cut has been made, move the slab until the slit line sticks out a 10 to 15 cm from the workbench. Start hew from both sides using appropriate cutting-off pliers and follow the scoring line to complete the hew.
- Smooth rough edges and sides with an appropriate diamond polishing pad.
- To drill internal cutouts from the slab, first you need to draw the guide lines. For circular cuts, use the compass device with suction cups. For rectangular cut, drill first a 5 – 7 mm hole at the corners of the rectangle shape, using a non-percussion drill. For a better drilling always, keep the surface and drill a little bit wet. Then Follow the drilled lines using a diamond-blade angle grinder and then finish off the edges with a diamond-polishing pad. Round holes (4) must be made in wet drilling, using diamond-blades. Start engraving the surface with a 75 degrees point angle, then straighten out the drill avoiding excessive pressure on the slab. Also, in this case finish with a diamond-polishing pad.
- Manual traction devices are available, in order to make a finishing cut at 45° and thus enable special applications of the material.



TECHNICAL MANUAL

Installation

Laying "Maximus" slabs requires similar laying conditions to those required for traditional format slabs. Maximus requires the adhesive to be applied both on the setting bed and on the back of the slab.

Maximus Slabs For Flooring Require The Following Conditions:

- A flat surface that is clean and free from dust, scraps and any lumps of cement
- The setting bed must be uniform and have already undergone the dry shrinkage process
- Repair any cracks
- Any uneven parts on the surface must be filled with suitable levelling compounds

Instruments Required

- Cement-based powder adhesive for full spread, class "C2E according to EN12004 and S1 according to EN12002 standards"
- 3x3 mm square toothed trowel and 15 mm round toothed trowel
- Frame with suction cups for handling or double suction cups
- Non-bounce plastic mallet 170x370 mm
- Levelling system: base clip + wedge + pliers

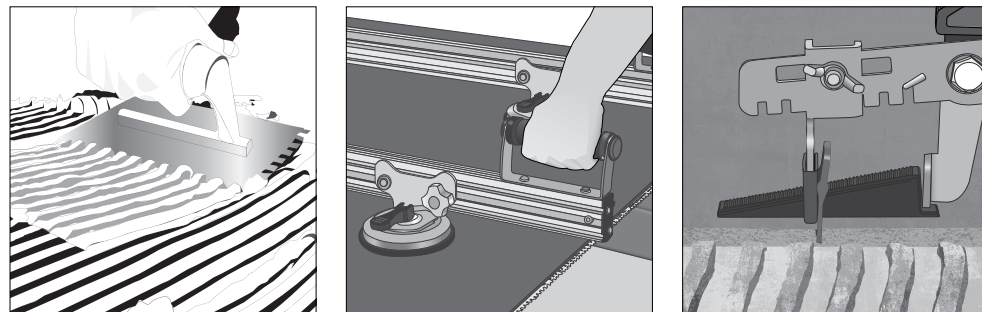

Bonding To The Floor

- Ensure that the surface to be covered is solid, flat and free from dust and oil/grease.
- Use the adhesives described above mixed according to the specifications indicated in the technical data sheet of the chosen adhesive.
- Spread the adhesive onto the surface to be covered with a 15 mm round toothed trowel across an area of 5/10 cm more than the dimensions of the slab.
- With the slab in a vertical position on the handling frame, spread the adhesive onto the back of the slab with a 3x3 mm square toothed trowel.
- Using the frame with suction cups, bring the slab into a horizontal position and lay it.
- To guarantee uniform bonding of the slab, the special 170x370 mm non-bounce plastic mallet must be used, tapping from the middle towards the edges so as to remove any air pockets between the back of the slab, the adhesive and the surface to be tiled using the levelling system.

Bonding To The Wall

- Ensure that the surface to be covered is solid, flat and free from dust.
- Cement-based powder adhesive for full spread, class "C2E according to EN12004 and S1 according to EN12002 standards".
- Spread the adhesive onto the surface to be covered with a 15 mm round toothed trowel across an area of 5/10 cm more than the dimensions of the slab.
- With the slab in a vertical position on the handling frame, spread the adhesive onto the back of the slab with a 3x3 mm square toothed trowel.
- Using the handling frame in a vertical position lay the slab.
- Before releasing the slab from the handling frame, ensure that the adhesive will hold it in place.
- To guarantee complete bonding of the slab and eliminate any air, tap from the middle towards the edges using the non-bounce plastic mallet.
- Before bonding the next slab, fix the hidden mechanical hook to the wall with the relevant nails (length 27 mm) using the gas-powered nailing machine.

Ventilated Façade

Maximus Mega Slab – Ventilated Façade Systems

A ventilated façade is a coating system on the outside of a building which leaves a ventilated chamber between the coating (façade) and the building insulation. Considered as the best solution for maximising insulation whilst reducing unwanted condensation or thermal bridge problems, ventilated façades provide excellent thermal-hygrometric solutions.

- Advantages of Ventilated Façade Systems
- Energy Saving – Excellent thermal insulation, reduction in heat/cool dispersal, and less heat absorption in warm climates.
- Technical and Aesthetic Durability – Significant reduction in deterioration due to pollution, does not absorb dust or dirt, easy to clean and maintain and promotes humidity dispersal.
- Healthier Environment – Increased comfort for users and meets all hygiene, health and environmental protection standards.



RAK CERAMICS India Pvt. Ltd.
Carnival House, 1st Floor,
Near Dindoshi Fire Station,
Off Gen. A. K. Vaidya Marg,
Malad (East). Mumbai 400097.
Maharashtra. India.
RAKCERAMICS.COM/INDIA
Toll Free: 18001025829

RAKCERAMICS.COM
